



Biolucci

ILUMINAÇÃO



CATÁLOGO
2026

www.biolucci.com.br

ÍNDICE



FITAS DE LED
PÁGINA 3



DRIVERS
PÁGINA 21



PERFIS FLEXÍVEIS
PÁGINA 30



PERFIS DE ALUMÍNIO
PÁGINA 44

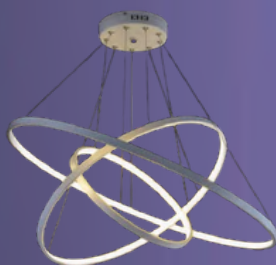

LUSTRE E PENDENTES
PÁGINA 56



FITAS DE LED E ACESSÓRIOS

WWW.BIOLUCCI.COM.BR

FITAS DE LED PREMIUM PRO

Tensão
24V

IP20

2 ANOS
DE
GARANTIA



Corte a cada 2,5cm

FITA COM
ALTA
EFICIENCIA EM
ILUMINAÇÃO

150
Lumens/w



Veja o vídeo
explicativo

Rolo 10m - IRC>80 - IP20 - 2700K

9,6W/m	1495 Lumens/m - 176 Leds/m	Cód. 789
14,4W/m	2150 Lumens/m - 176 Leds/m	Cód. 788
22W/m	3300 Lumens/m - 240 Leds/m	Cód. 787

Rolo 25m - IRC>80 - IP20

9,6W/m	1536 Lumens/m - 176 Leds/m - 3000k	Cód. 783
9,6W/m	1536 Lumens/m - 176 Leds/m - 4000k	Cód. 784
22W/m	3520 Lumens/m - 240 Leds/m - 3000k	Cód. 785
22W/m	3520 Lumens/m - 240 Leds/m - 4000k	Cód. 786

Observações de instalação

- Para segmentos maiores que 10 metros, sempre fazer a ligação da fonte nas duas pontas da Fita de Led.
- Para segmentos menores que 10 metros pode-se ligar apenas de um dos lados.
- Recomendamos apenas o uso de fontes Biolucci e com potência 20% acima do exigido pelo segmento.

Tensão
12v

IP20



Corte a cada 2,5cm

ATÉ 50.000
HORAS DE
VIDA UTIL2 ANOS
DE
GARANTIA

Largura: 10mm

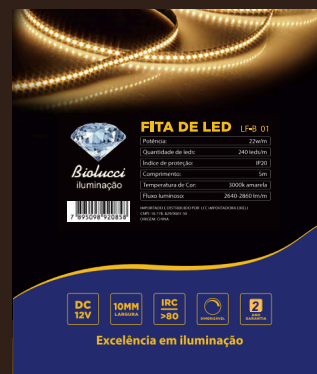
**Rolo 5m - IRC>80 - IP20**

4,8W/m	700 Lumens/m - 2700k - 176 Leds/m	Cód. 404
4,8W/m	700 Lumens/m - 3000k - 176 Leds/m	Cód. 1112
4,8W/m	700 Lumens/m - 4000k - 176 Leds/m	Cód. 1113
4,8W/m	700 Lumens/m - 6000k - 176 Leds/m	Cód. 1152
9,6W/m	1250 Lumens/m - 2700k - 176 Leds/m	Cód. 1116
9,6W/m	1400 Lumens/m - 3000k - 176 Leds/m	Cód. 1107
9,6W/m	1400 Lumens/m - 4000k - 176 Leds/m	Cód. 1108
9,6W/m	1400 Lumens/m - 6000k - 176 Leds/m	Cód. 1109
14,4W/m	2017 Lumens/m - 2700k - 176 Leds/m	Cód. 790
14,4W/m	2017 Lumens/m - 3000k - 176 Leds/m	Cód. 1104
14,4W/m	2017 Lumens/m - 4000k - 176 Leds/m	Cód. 1105
14,4W/m	2017 Lumens/m - 6000k - 176 Leds/m	Cód. 1106
22W/m	2750 Lumens/m - 2700k - 240 Leds/m	Cód. 1115
22W/m	2750 Lumens/m - 3000k - 240 Leds/m	Cód. 1101
22W/m	2750 Lumens/m - 4000k - 240 Leds/m	Cód. 1102
22W/m	2750 Lumens/m - 6000k - 240 Leds/m	Cód. 1110

Observações de instalação

- Para segmentos maiores que 5 metros, sempre fazer a ligação da fonte nas duas pontas da Fita de Led.
- Para segmentos menores que 5 metros pode-se ligar apenas de um dos lados.
- Recomendamos apenas o uso de fontes Biolucci e com potência 20% acima do exigido pelo segmento.

Veja o vídeo
explicativo

FITAS DE LED PREMIUM

Tensão
12v

2 ANOS
DE GARANTIA

IP65

Resistente
apenas á
respingos e
poeira

Corte a cada 2,5cm



Largura: 10mm

Rolo 5m - IRC>80 - IP65

9,6W/m	1400 Lumens/m - 3000k - 176 Leds/m	Cód. 1117
9,6W/m	1400 Lumens/m - 4000k - 176 Leds/m	Cód. 1151
22W/m	2750 Lumens/m - 3000k - 240 Leds/m	Cód. 1103
22W/m	2750 Lumens/m - 4000k - 240 Leds/m	Cód. 1111



FITAS DE LED PREMIUM

Tensão
24v

IP67

2 ANOS
DE GARANTIA



Largura: 10mm

Corte a cada 2,5cm

Rolo 10m - IRC>80 - IP67

14,4W/m	1750 Lumens/m - 3000k - 176 Leds/m	Cód. 541
14,4W/m	1750 Lumens/m - 4000k - 176 Leds/m	Cód. 542

Acessórios para Fita IP67



Ponteira para vedação
Cód. 554



Conector de alimentação
Cód. 553



Veja o vídeo
explicativo



Observações de instalação

- **Importante:** Fazer a vedação correta da Fita IP67 conforme dito no vídeo para ter uma boa proteção contra água.
- **Importante:** A Fita IP65 não é recomendada para uso externo com perfis de alumínio. Para isso use a IP67 ou Perfis Flexíveis de Silicone de área externa.
- Recomendamos apenas o uso de fontes Biolucci e com potência 20% acima do exigido pelo segmento.



Tabela de proteção IP

5	Protegido contra poeira. Possibilidade de entrada de poeira	5	Protegido contra projeção de jatos d'água
6	Totalmente protegido contra poeira, sem possibilidade de entrada	6	Protegido contra projeção de jatos d'água potentes
Exemplo		7	Protegido contra imersão temporária em água de até 1 metro por 30 minutos
IP	6	7	Protegido contra imersão contínua em água de até 3 metro

FITAS DE LED
PREMIUMTensão
12v

IP20



Corte a cada 2,5cm

Veja o vídeo
explicativoATÉ 50.000
HORAS DE
VIDA UTIL2 ANOS
DE
GARANTIA

Largura: 10mm

Rolo 30m - IRC>80 - IP20

14,4W/m	1895 Lumens/m - 3000k - 176 Leds/m	Cód. 546
14,4W/m	1895 Lumens/m - 4000k - 176 Leds/m	Cód. 547
14,4W/m	1895 Lumens/m - 6000k - 176 Leds/m	Cód. 548
22W/m	2850 Lumens/m - 3000k - 240 Leds/m	Cód. 543
22W/m	2850 Lumens/m - 4000k - 240 Leds/m	Cód. 544
22W/m	2850 Lumens/m - 6000k - 240 Leds/m	Cód. 545

DUPLA

FITAS DE LED
PREMIUMTensão
12v e 24v

IP20



Corte a cada 2,5cm

DUPLO LED
CHEGANDO Á
ATÉ 5.000
LUMENS/M2 ANOS
DE
GARANTIA

Largura: 18mm

Rolo 5m - IRC>80 - IP20

40W/m	4800 Lumens/m - 3000k - 320 Leds/m - 12V	Cód. 331
40W/m	4800 Lumens/m - 4000k - 320 Leds/m - 12V	Cód. 332

Rolo 10m - IRC>80 - IP20

40W/m	4800 Lumens/m - 3000k - 320 Leds/m - 24V	Cód. 333
40W/m	4800 Lumens/m - 4000k - 320 Leds/m - 24V	Cód. 334

FITAS DE LED PREMIUM

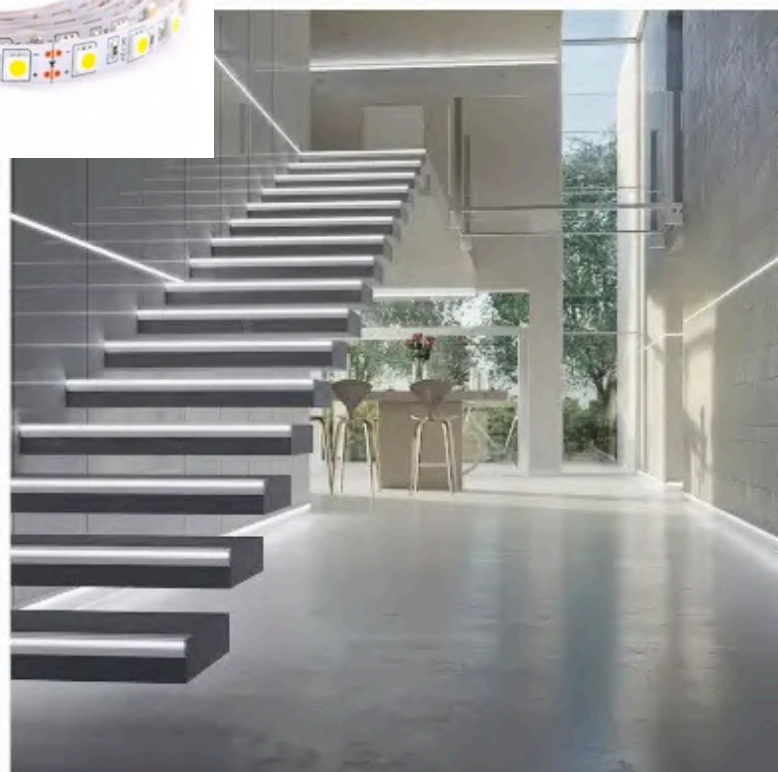
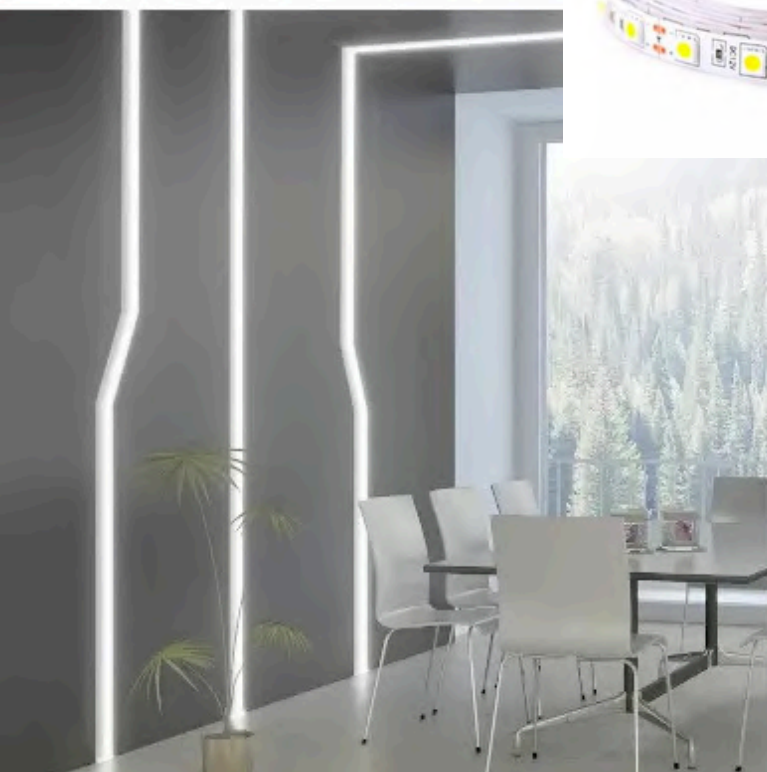
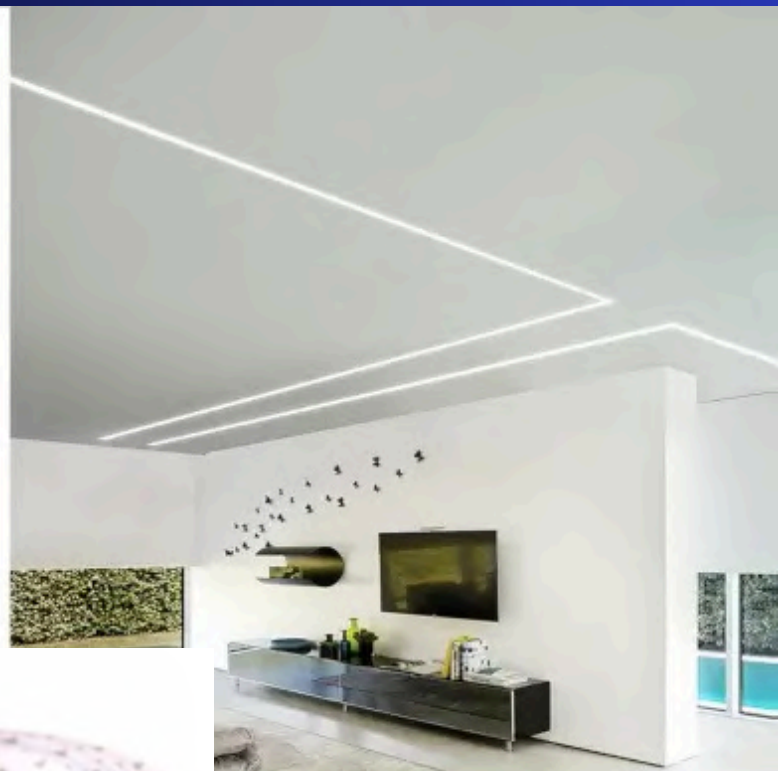
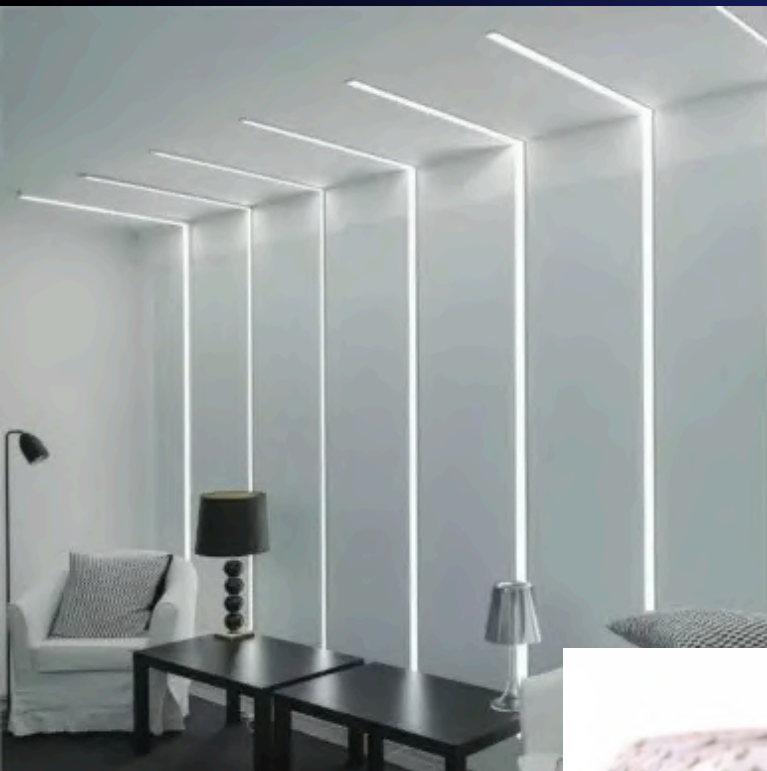

FITAS DE LED
PREMIUM

IRC > 90

Tensão
12v

IP20

Corte : 12V 176 Leds/m 2.72cm

CORES MAIS
REAIS E
AUTENTICAS2 ANOS
DE
GARANTIA

Largura: 10mm



Rolo 5m - IRC > 90 - IP20

9,6W/m	1250 Lumens/m - 3000k - 176 Leds/m	Cód. 369
9,6W/m	1300 Lumens/m - 4000k - 176 Leds/m	Cód. 370
14,4W/m	1750 Lumens/m - 3000k - 176 Leds/m	Cód. 371
14,4W/m	1800 Lumens/m - 4000k - 176 Leds/m	Cód. 372

4mm BABY

FITAS DE LED
PREMIUMTensão
12v

IP20

Corte: 12V 128 Leds/m 3.125cm

PERFEITA
PARA MOVEIS
E ARMARIOS2 ANOS
DE
GARANTIA

Largura: 4mm



Rolo 5m - IRC > 80 - IP20

10W/m	1250 Lumens/m - 2700k - 128 Leds/m	Cód. 130
10W/m	1350 Lumens/m - 3000k - 128 Leds/m	Cód. 131
10W/m	1450 Lumens/m - 4000k - 128 Leds/m	Cód. 132

FITAS DE LED
PREMIUM

COB

Tensão
12v

IP20



Corte: 12V 320Leds/m 2.5cm

PODE-SE
USAR EM
PERFIS SEM
DIFUSOR2 ANOS
DE
GARANTIA

Largura: 8mm

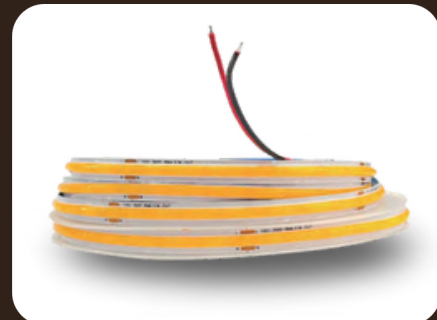
**Rolo 5m - IRC>90 - IP20**

10W/m	875 Lumens/m - 3000k - 320 Leds/m	Cód. 328
10W/m	925 Lumens/m - 4000k - 320 Leds/m	Cód. 329

LIGAÇÃO ULTRA LONGA

FITAS DE LED
PREMIUMTensão
24v

IP20



Corte: 24V 480Leds/m 5cm

LIGAÇÃO
ULTRA LONGA:
20 metros2 ANOS
DE
GARANTIA

Largura: 8mm

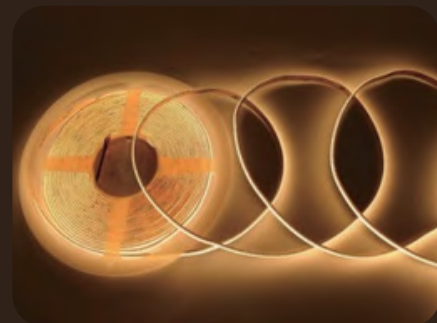
**Rolo 20m - IRC>90 - IP20**

7.5W/m	670 Lumens/m - 3000k - 480 Leds/m	Cód. 118
7.5W/m	670 Lumens/m - 4000k - 480Leds/m	Cód. 119

10

ACESSE NOSSO SITE
BIOLUCCI.COM.BR

FITAS DE LED PREMIUM

ULTRA POWER

Tensão
24v

IP20



Corte: 24V 304Leds/m 2.63cm

ALTA
CONCENTRAÇÃO
DE LEDS
+ LUMENS/M

2 ANOS
DE
GARANTIA



Largura: 10mm



Rolo 5m - IRC>80 - IP20

28W/m	3640 Lumens/m - 3000k - 304 Leds/m	Cód. 1164
28W/m	3780 Lumens/m - 4000k - 304 Leds/m	Cód. 1165

AZUL

FITAS DE LED PREMIUM

Tensão
24v

IP20



Corte: 24V 128Leds/m 6.25cm

Pode-se
usar em
perfis sem a
lente difusora

2 ANOS
DE
GARANTIA



Largura: 8mm

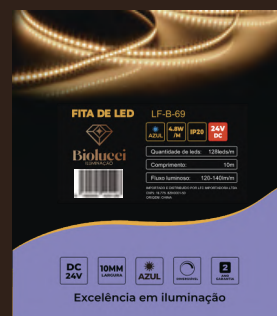

Rolo 10m - AZUL - IP20

4.8W/m	130 Lumens/m - AZUL - 128 Leds/m	Cód. 108
9.6W/m	240 Lumens/m - AZUL - 128 Leds/m	Cód. 109

IRC > 90

Tensão
24v

IP20

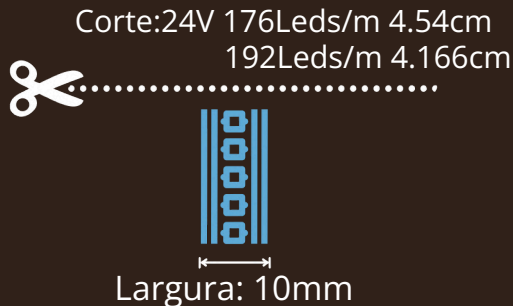
Melhor fidelização
da cor com efeitos
mais naturais2 ANOS
DE
GARANTIA

Rolo 10m - IRC > 90 - IP20

9.6W/m	1250 Lumens/m - 3000k - 176 Leds/m	Cód. 112
14.4W/m	1750 Lumens/m - 3000k - 176 Leds/m	Cód. 110
22W/m	2500 Lumens/m - 3000k - 192 Leds/m	Cód. 111

Observações de instalação

- Para segmentos maiores que 10 metros ,sempre fazer a ligação da fonte nas duas pontas da Fita de Led.
- Para segmentos menores que 10 metros pode-se ligar apenas de um dos lados.
- Recomendamos o uso de uma fonte confiável e 20% mais potente que o exigido pelo segmento.

ENDEREÇÁVEL

FITAS DE LED PREMIUM

Tensão **24v**

IP20

Corte a cada 5cm

FUNÇÃO
RUNNING E
MAIS UMA
GRANDE
VARIEDADE

2 ANOS
DE
GARANTIA



Veja o vídeo explicativo



Rolo 10m - IRC>80 - IP20

9W/m	950 Lumens/m - 3000k - 126 Leds/m	Cód. 335
9W/m	950 Lumens/m - 4000k - 126 Leds/m	Cód. 336

Acessórios para Fita



Controle de 3 teclas
Cód. 338

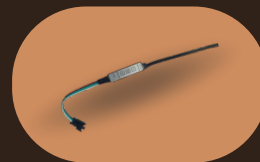

Mini Controlador
Cód. 337

CCT
De 3000K à 6000K

FITAS DE LED PREMIUM

Tensão **24v**

IP20

Corte a cada 2,5cm

TECNOLOGIA
DE BI-LEDS
DO 3000K À 6000K
EM APENAS 1 LED

2 ANOS
DE
GARANTIA



Veja o vídeo explicativo



Rolo 5m - IRC>80 - IP20

22W/m	3640 Lumens/m - 3000k - 304 Leds/m	Cód. 1164
-------	------------------------------------	-----------

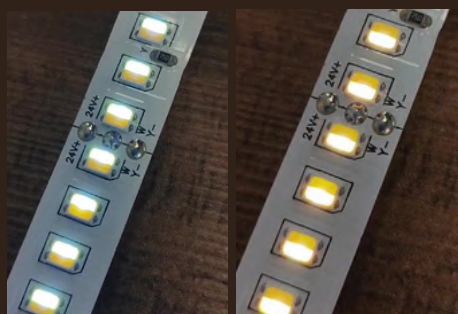

Acessórios para Fita



Controle Manual
Cód. 549



Emenda de pressão 3 polos
Cód. 384

Tensão
24V

IP20

Corte a cada 2,5cm

ATÉ 50.000
HORAS DE
VIDA UTIL

2 ANOS
DE
GARANTIA



Largura: 10mm



Rolo 10m - IRC>80 - IP20

9,6W/m	1400 Lumens/m - 3000k - 176 Leds/m	Cód. 120
9,6W/m	1400 Lumens/m - 4000k - 176 Leds/m	Cód. 121
14,4W/m	2017 Lumens/m - 3000k - 176 Leds/m	Cód. 1153
14,4W/m	2017 Lumens/m - 4000k - 176 Leds/m	Cód. 1154
22W/m	2750 Lumens/m - 3000k - 240 Leds/m	Cód. 122
22W/m	2750 Lumens/m - 4000k - 240 Leds/m	Cód. 123

Rolo 30m - IRC>80 - IP20

14,4W/m	2017 Lumens/m - 3000k - 176 Leds/m	Cód. 1155
14,4W/m	2017 Lumens/m - 4000k - 176 Leds/m	Cód. 1156

Rolo 30m - IRC>80 - IP65

14,4W/m	2017 Lumens/m - 3000k - 176 Leds/m	Cód. 1157
14,4W/m	2017 Lumens/m - 4000k - 176 Leds/m	Cód. 1158

Observações de instalação

- Para segmentos maiores que 10 metros, sempre fazer a ligação da fonte nas duas pontas da Fita de Led.
- Para segmentos menores que 10 metros pode-se ligar apenas de um dos lados.
- Recomendamos apenas o uso de fontes Biolucci e com potência 20% acima do exigido pelo segmento.



Veja o vídeo
explicativo



RGB

FITAS DE LED
PREMIUM



FITAS DE LED PREMIUM

RGB 12v

Tensão
12v

IP20

Corte a cada 1,8cm

Pode ser ligada em conjunto com o controlador 5 em 1 wifi

2 ANOS
DE
GARANTIA



Veja o vídeo explicativo



Rolo 5m - IP20

24W/m

650 Lumens/m - 162 Leds/m

Cód. 1114

Acessórios para Fita

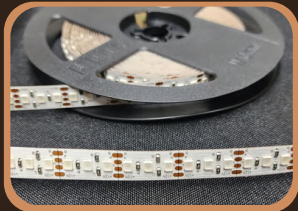

RGB MAGIC

FITAS DE LED PREMIUM

Tensão
24v

IP20

Corte a cada 10cm

Possui mais de 50 Modos variados Controlada via Bluetooth com Celular

2 ANOS
DE
GARANTIA

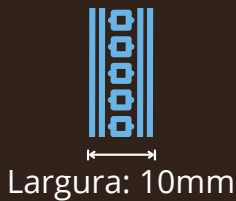

Veja o vídeo explicativo



Rolo 10m - IP20

12W/m

SMD 5050 - 60 Leds/m

Cód. 312

Acessórios para Fita

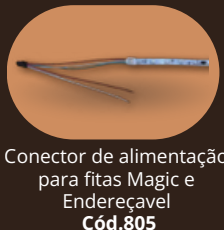
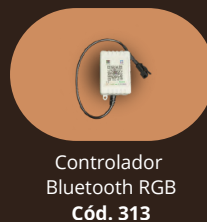

FITAS DE LED
PREMIUM

COB RGB MAGIC

Tensão
24V

IP20



Corte: 24V 420Leds/m 10cm

Possui mais de 50
Modos variados,
Modo Musica,
controlada via
Bluetooth com
Celular2 ANOS
DE
GARANTIA

Largura: 10mm



Rolo 10m -R GB IC- IP 20

10W/m

COB -RGB IC-420Leds/m -10 2811 IC/m SPI

Cód. 113

Acessórios para Fita

Controle manual e
Bluetooth RGB
Cód. 96Controlador
Bluetooth RGB
Cód. 313Amplificador pa
fita RGB Magic
Cód. 1168Conector de
alimentação para fitas
COB Magic 10mm
Cód.1173Emenda de 3 polos
para fitas COB
RGB10mm
Cód.1172

COB RGBW

Tensão
24V

IP20



Corte: 24V 672Leds/m 7.143cm

Equilíbrio do
espectro de
cores com a
iluminação2 ANOS
DE
GARANTIA

Larguras: 12mm



Rolo 10m-RGBW (W IRC>90)-IP20

15W/m

COB -RGB W3000K -672Leds/m

Cód. 114

15W/m

COB -RGB W4000K -672Leds/m

Cód. 115

Acessórios para Fita

Amplificador pa
fita RGBW
Cód. 1169Conector de
alimentação 5 polos
para fitas COB RGBW12mm
Cód.1170Emenda de 5 polos
para fitas COB
RGBW12mm
Cód.1171CONTROLADO R
WIFI 5 EM 1
Cód.1166

FITAS DE LED PREMIUM

RGB NEON MAGIC

Tensão **24v**

IP65

Corte a cada 6,3cm

Possui mais de 50 Modos variados, Modo Musica, controlada via Bluetooth com Celular

2 ANOS DE GARANTIA



Largura: 8x16mm



Veja o vídeo explicativo



Rolo 10m - IP65

21W/m

SMD 3535 - 96 Leds/m

Cód. 458

Acessórios para Fita



Amplificador para fita RGB Magic
Cód.1168



Controle manual e Bluetooth RGB
Cód. 96



Controlador Bluetooth RGB
Cód. 313

NEON

FITAS DE LED PREMIUM

Tensão **12v**

IP65

2 ANOS DE GARANTIA

Com 100% Silicone trazendo mais brilho e proteção.

Vendida também de metro em metro

Recomendada para ligações até 5 metros sem perda de lumens

Corte a cada 2,5cm



Larguras: 8x16mm e 6x12mm

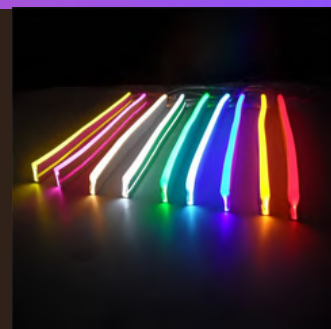

Rolo 50m - 9W/m - 6x12mm

Rolo 50m - 9W/m - 8x16mm

Branco Frio	SMD 2835 - 120 Leds/m	Cód. 303	Branco Frio	SMD 2835 - 120 Leds/m	Cód. 1120
Branco Morno	SMD 2835 - 120 Leds/m	Cód. 304	Branco Morno	SMD 2835 - 120 Leds/m	Cód. 1119
Laranja	SMD 2835 - 120 Leds/m	Cód. 306	Laranja	SMD 2835 - 120 Leds/m	Cód. 1128
Azul	SMD 2835 - 120 Leds/m	Cód. 302	Azul	SMD 2835 - 120 Leds/m	Cód. 1118
Azul Gelo	SMD 2835 - 120 Leds/m	Cód. 301	Azul Gelo	SMD 2835 - 120 Leds/m	Cód. 1124
Amarelo	SMD 2835 - 120 Leds/m	Cód. 127	Amarelo	SMD 2835 - 120 Leds/m	Cód. 124
Amarelo limão	SMD 2835 - 120 Leds/m	Cód. 307	Amarelo limão	SMD 2835 - 120 Leds/m	Cód. 1127
Vermelho	SMD 2835 - 120 Leds/m	Cód. 315	Vermelho	SMD 2835 - 120 Leds/m	Cód. 1123
Verde	SMD 2835 - 120 Leds/m	Cód. 314	Verde	SMD 2835 - 120 Leds/m	Cód. 1122
Rosa	SMD 2835 - 120 Leds/m	Cód. 308	Rosa	SMD 2835 - 120 Leds/m	Cód. 1125

FITAS DE LED
PREMIUM

NEON

Tensão
24v

IP65

2 ANOS
DE
GARANTIACom 100%
Silicone
trazendo mais
brilho e
proteção.Vendida
também de
metro em metroRecomendada
para ligações
até 10 metros
sem perda de
lumens Corte a cada 2,5cm...

Larguras: 8x16mm e 6x12mm



Rolo 50m - 9W/m - 6x12mm

Branco Frio	SMD 2835 - 120 Leds/m	Cód. 757
Branco Morno	SMD 2835 - 120 Leds/m	Cód. 756
Branco Quente	SMD 2835 - 120 Leds/m	Cód. 755
Azul	SMD 2835 - 120 Leds/m	Cód. 80
Azul Gelo	SMD 2835 - 120 Leds/m	Cód. 79
Amarelo	SMD 2835 - 120 Leds/m	Cód. 78
Limão	SMD 2835 - 120 Leds/m	Cód. 82
Vermelho	SMD 2835 - 120 Leds/m	Cód. 85
Verde	SMD 2835 - 120 Leds/m	Cód. 84
Rosa	SMD 2835 - 120 Leds/m	Cód. 83
Violeta	SMD 2835 - 120 Leds/m	Cód. 86
Laranja	SMD 2835 - 120 Leds/m	Cód. 81

Rolo 50m - 9W/m - 8x16mm

Branco Quente	SMD 2835 - 120 Leds/m	Cód. 1128
Branco Morno	SMD 2835 - 120 Leds/m	Cód. 1119

Acessórios para
Fitas NeonClipe de Fixação
Cód. 343Tampa para Fita
Cód. 317 à 327

ACESSÓRIOS

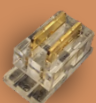
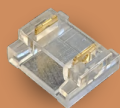
FITAS DE LED
PREMIUMConector de
Alimentação
Para Fita de 4mm
Cód. 97Conector de
Alimentação
Para Fita 10mm
Cód. 744Mini Controlador
da Fita
Endereçável
Cód. 337Amplificador
4 Saídas da
Fita Endereçável
Cód. 340Amplificador
8 Saídas da
Fita Endereçável
Cód. 341Emenda de Pressão
Para Fita 4mm
2 Polos 180°
Cód. 383Emenda de Pressão
Para Fita 10mm
2 Polos 180°
Cód. 383Emenda de Pressão
Para Fita 10mm
3 Polos 180°
Cód. 384Emenda de Pressão
Para Fita 10mm
4 Polos 180°
Cód. 385Emenda de Pressão
Para Fita 10mm
2 Polos 90° "L"
Cód. 386

FITAS DE LED
STANDARDTensão
12v

IP20



Corte a cada 2,5cm

ATÉ 25.000
HORAS DE
VIDA UTIL2 ANOS
DE
GARANTIA

Largura: 10mm



Rolo 5m - IRC>80 - IP20

8,5W/m	800 Lm/m - 2700k - 180 Leds/m - 8mm	Cód. 455
8,5W/m	900 Lm/m - 3000k - 180 Leds/m - 8mm	Cód. 456
8,5W/m	900 Lm/m - 4000k - 180 Leds/m - 8mm	Cód. 486
8,5W/m	900 Lm/m - 6000k - 180 Leds/m - 8mm	Cód. 457
13,5W/m	1250 Lm/m - 2700k - 180 Leds/m - 10mm	Cód. 452
13,5W/m	1400 Lm/m - 3000k - 180 Leds/m - 10mm	Cód. 453
13,5W/m	1400 Lm/m - 4000k - 180 Leds/m - 10mm	Cód. 454
13,5W/m	1400 Lm/m - 6000k - 180 Leds/m - 10mm	Cód. 485
21W/m	1900 Lm/m - 2700k - 240 Leds/m - 9,6mm	Cód. 479
21W/m	2150 Lm/m - 3000k - 240 Leds/m - 9,6mm	Cód. 483
21W/m	2150 Lm/m - 4000k - 240 Leds/m - 9,6mm	Cód. 451
21W/m	2150 Lm/m - 6000k - 240 Leds/m - 9,6mm	Cód. 484

Observações de instalação

- Recomendamos apenas o uso de fontes Biolucci e com potência 20% acima do exigido pelo segmento.



DRIVERS E DIMMERS

WWW.BIOLUCCI.COM.BR

DRIVER ULTRAFINO 12V

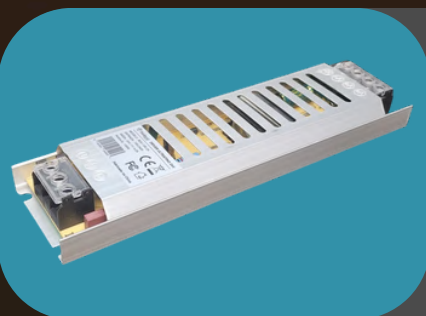
**ULTRAFINO ABERTO 8.3A 100W**Código: **510**

- Potência 100W
- Bivolt 110v à 220v
- Proteção IP20
- Dimensão: 195x53x22mm

ULTRAFINO ABERTO 16.7A 200WCódigo: **511**

- Potência 200W
- Bivolt 110v à 220v
- Proteção IP20
- Dimensão: 235x53x22mm

DRIVER ULTRAFINO 24V

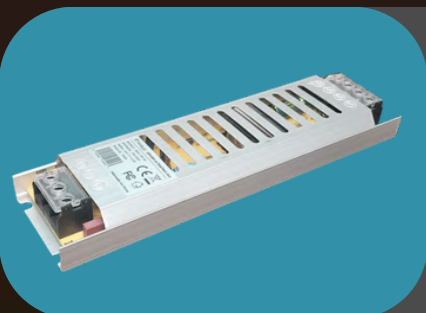
**ULTRAFINO ABERTO 4.2A 100w**Código: **512**

- Potência 100W
- Bivolt 110v à 220v
- Proteção IP20
- Dimensão: 195x53x22mm

ULTRAFINO ABERTO 8.5A 200WCódigo: **513**

- Potência 200W
- Bivolt 110v à 220v
- Proteção IP20
- Dimensão: 315x52x22mm

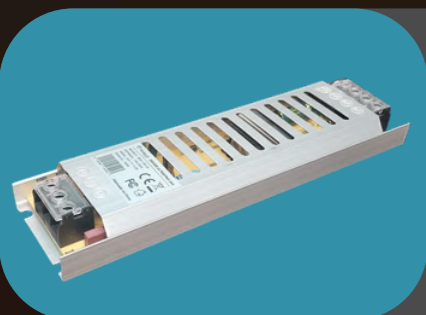
**ULTRAFINO ABERTO 12.5A 300W**Código: **405**

- Potência 300W
- Bivolt 110v à 220v
- Proteção IP20
- Dimensão: 320x52x22mm

ULTRAFINO ABERTO 16.7A 400WCódigo: **406**

- Potência 400W
- Bivolt 110v à 220v
- Proteção IP20
- Dimensão: 375x52x22mm

Quantos watts são necessários para o segmento?

- O cálculo base é: multiplicar watts/m do segmento da Fita e dividir pela voltagem do driver (12v ou 24v).
- Nunca use um Driver menor do que o resultado do cálculo.
- **Exemplo: Segmento - 3 metros de Fita 22w/m. Será necessário um driver de no mínimo 66w.**
- O ideal é sempre trabalhar com pelo menos 20% a mais do necessário para o segmento.

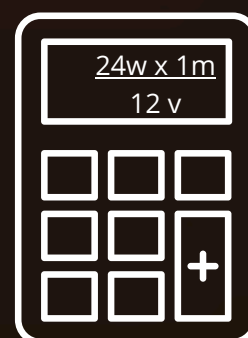

DRIVERS

DRIVER SLENDER BASTÃO 12V

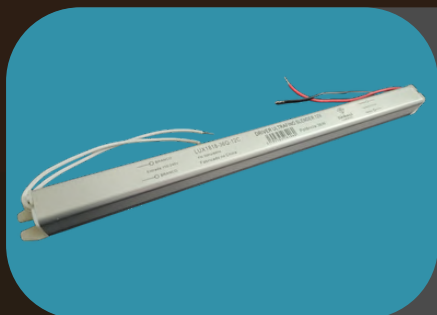
**SLENDER BASTÃO 3A 36W**Código: **1226**

- Potência 36W
- Bivolt 110v à 220v
- Proteção IP20
- Dimensão: 235x18x18mm

SLENDER BASTÃO 6A 72WCódigo: **1227**

- Potência 72W
- Bivolt 110v à 220v
- Proteção IP20
- Dimensão: 315x18x18mm

DRIVER SLENDER BASTÃO 24V

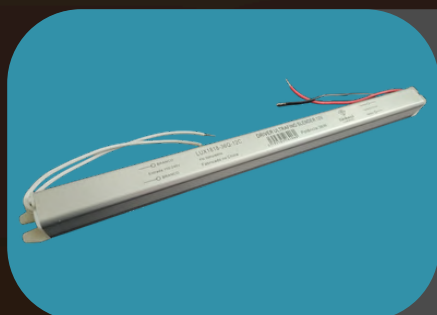
**SLENDER BASTÃO 1.5A 36W**Código: **508**

- Potência 36W
- Bivolt 110v à 220v
- Proteção IP20
- Dimensão: 235x18x18mm

SLENDER BASTÃO 3A 72WCódigo: **509**

- Potência 72W
- Bivolt 110v à 220v
- Proteção IP20
- Dimensão: 315x18x18mm

DRIVER SLIM P2030 12V – IP67 **DRIVER SLIM P2030 60W**Código: **489**

- Potência 60W
- Bivolt 110v à 220v
- Proteção IP67
- Dimensão: 125x30x20mm

DRIVER SLIM P2030 100WCódigo: **192**

- Potência 100W
- Bivolt 110v à 220v
- Proteção IP67
- Dimensão: 274x30x20mm

DRIVER SLIM P2030 24V – IP67 **DRIVER SLIM P2030 60W**Código: **438**

- Potência 60W
- Bivolt 110v à 220v
- Proteção IP67
- Dimensão: 125x30x20mm

DRIVER SLIM P2030 100WCódigo: **193**

- Potência 100W
- Bivolt 110v à 220v
- Proteção IP67
- Dimensão: 274x30x20mm

DRIVER STRIP SHAPE 12V

**STRIP SHAPE 5A 60W**

Código: 1220

- Potência 60W
- Bivolt 110v à 220v
- Proteção IP20
- Dimensão: 160x40x32mm

STRIP SHAPE 10A 120W

Código: 1221

- Potência 120W
- Bivolt 110v à 220v
- Proteção IP20
- Dimensão: 188x45x35mm

DRIVER STRIP SHAPE 12V

**STRIP SHAPE 16.7A 200W**

Código: 1222

- Potência 200W
- Bivolt 110v à 220v
- Proteção IP20
- Dimensão: 224x66x42mm

DRIVER DS-2253 SLIM 12V

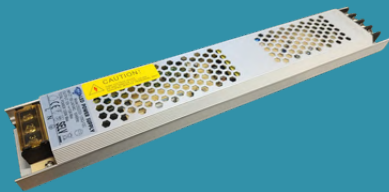
**DS-2253-12C-20 10A 120W**

Código: 1206

- Potência 120W
- Bivolt 110v à 220v
- Proteção IP20
- Dimensão: 310x22x53mm

DRIVER S-FS30 12V - IP67 **DRIVER S-FS30 2.5A 30W**

Código: 1223

- Potência 30W
- Bivolt 110v à 220v
- Proteção IP67
- Dimensão: 240x22x21mm

DRIVERS

DRIVER FONTE CHAVEADA 12V

**FONTE CHAVEADA 5A 60W**

Código: 1210

- Potência 60W
- Bivolt 110v à 220v
- Proteção IP20
- Dimensão: 86x58x38mm

DRIVER FONTE CHAVEADA 12V

**FONTE CHAVEADA 10A 120W**

Código: 1211

- Potência 120W
- Bivolt 110v à 220v
- Proteção IP20
- Dimensão: 160x98x40mm

FONTE CHAVEADA 15A 180W

Código: 1212

- Potência 180W
- Bivolt 110v à 220v
- Proteção IP20
- Dimensão: 192x96x42mm

DRIVER FONTE CHAVEADA 12V

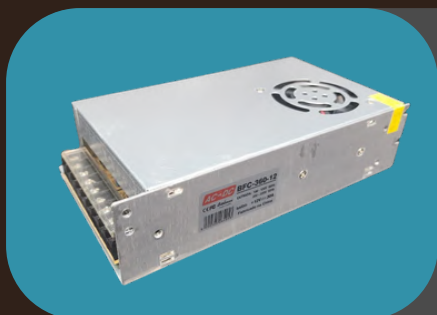
**FONTE CHAVEADA 20A 240W**

Código: 1214

- Potência 240W
- Bivolt 110v à 220v
- Proteção IP20
- Dimensão: 192x97x40mm

FONTE CHAVEADA 30A 360W

Código: 1213

- Potência 360W
- Bivolt 110v à 220v
- Proteção IP20
- Dimensão: 200x110x50mm

Quantos watts são necessários para o segmento?

- O cálculo base é: multiplicar watts/m do segmento da Fita e dividir pela voltagem do driver (12v ou 24v).
- Nunca use um Driver menor do que o resultado do cálculo.
- **Exemplo: Segmento - 3 metros de Fita 22w/m. Será necessário um driver de no mínimo 66w.**
- O ideal é sempre trabalhar com pelo menos 20% a mais do necessário para o segmento.

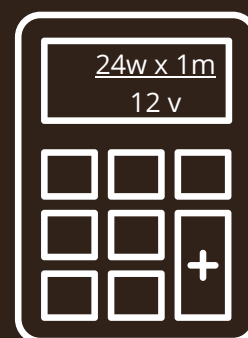

DRIVERS

DRIVER LUX3556 12V – IP67 **DRIVER LUX3556-60Q 60W**Código: **487**

- Potência 60W
- Bivolt 110v à 220v
- Proteção IP67
- Dimensão: 103x53x35mm

DRIVER LUX3556 12V – IP67 **DRIVER LUX3556-120Q 120W**Código: **194**

- Potência 120W
- Bivolt 110v à 220v
- Proteção IP67
- Dimensão: 170x56x35mm

DRIVER LUX3556-240Q 240WCódigo: **436**

- Potência 240W
- Bivolt 110v à 220v
- Proteção IP67
- Dimensão: 240x56x35mm

DRIVER LUX3556 24V – IP67 **DRIVER LUX3556-60Q 60W**Código: **435**

- Potência 60W
- Bivolt 110v à 220v
- Proteção IP67
- Dimensão: 103x53x35mm

DRIVER LUX3556 24V – IP67 **DRIVER LUX3556-120Q 120W**Código: **1233**

- Potência 120W
- Bivolt 110v à 220v
- Proteção IP67
- Dimensão: 197x55x35mm

DRIVER LUX3556-240Q 240WCódigo: **195**

- Potência 240W
- Bivolt 110v à 220v
- Proteção IP67
- Dimensão: 240x56x35mm

DRIVERS

DRIVER LUX3556 **48V** - IP67 

Ideal para usar
com o perfil
SL-06 48v

**DRIVER LUX3556 100W**

Código: 773

- Potência 100W
- Bivolt 110v à 220v
- Proteção IP67
- Dimensão: 197x53x33mm

DRIVER LUX3556 **48V** - IP67 **DRIVER LUX3556 150W**

Código: 774

- Potência 150W
- Bivolt 110v à 220v
- Proteção IP67
- Dimensão: 225x55x35mm

DRIVER LUX3556 250W

Código: 775

- Potência 250W
- Bivolt 110v à 220v
- Proteção IP67
- Dimensão: 246x54x34mm

MINI DRIVER DS 12V

**DRIVER DS-30 30W**

Código: 1216

- Potência 30W
- Bivolt 110v à 220v
- Proteção IP20
- Dimensão: 110x40x25mm

DRIVER DS-60 60W

Código: 1202

- Potência 60W
- Bivolt 110v à 220v
- Proteção IP20
- Dimensão: 135x40x30mm

MINI DRIVER YSV-024D 12V

**DRIVER YSV-024D 2A 24W**

Código: 437

- Potência 24W
- Entrada 220v
- Proteção IP20
- Dimensão: 50x50x20mm

DRIVERS
DIMMERS

DRIVER CBV-360Q-24 24V

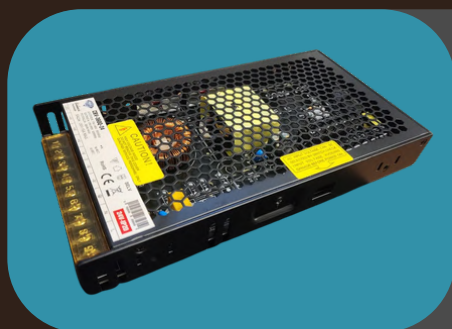
**DRIVER CBV-360Q 15A 360W**

Código: 1232

- Potência 360W
- Bivolt 110v à 220v
- Proteção IP20
- Dimensão: 213x115x38mm

DRIVER SLV-360Q-24 24V - IP67 **DRIVER SLV-360Q 15A 360W**

Código: 1234

- Potência 360W
- Bivolt 110v à 220v
- Proteção IP67
- Dimensão: 240x60x40mm

MINI TITAN-100Q-24CX 24v - IP20

**MINITITAN100Q-24CX**

Código: 117

- Potência 100W
- Bivolt 110v à 240v
- Proteção IP20
- Dimensão: 64x48x15.5mm

Quantos watts são necessários para o segmento?

- O cálculo base é: multiplicar watts/m do segmento da Fita e dividir pela voltagem do driver (12v ou 24v).
- Nunca use um Driver menor do que o resultado do cálculo.
- **Exemplo: Segmento - 3 metros de Fita 22w/m. Será necessário um driver de no mínimo 66w.**
- O ideal é sempre trabalhar com pelo menos 20% a mais do necessário para o segmento.

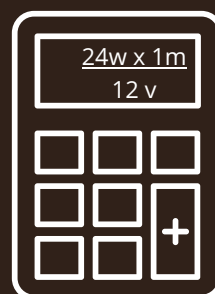

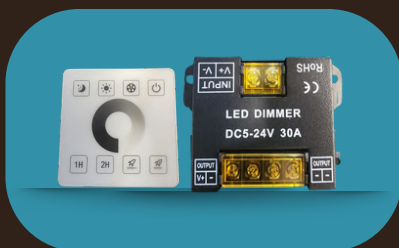
DRIVERS
DIMMERS

Dimmer Para Fita
de Led RF 3 Saídas
Cód. 97



Veja o vídeo
explicativo ↑



Dimmer Para Fita
de Led RF 3 Saídas
Com Bluetooth
Cód. 804



Dimmer Para Fita
de Led RF 2 Saídas
Cód. 98



↑ Veja o vídeo
explicativo



Amplificador para
fita RGBW
Cód. 1169



Amplificador
para fita RGB
Cód. 1174



Amplificador
para fita RGB Magic
Cód.1168

CONTROLADOR WIFI 5 EM 1

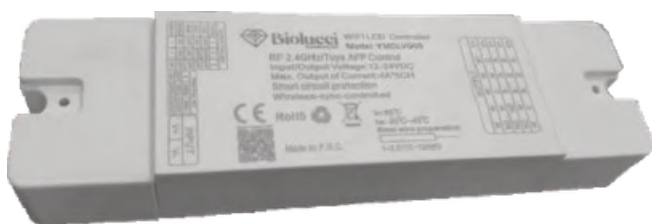

- Compatível com automação por Alexa e Tuya
- Dimerizador quando acoplado ao driver
- Controlador da Fita CCT
- Controlador da Fita RGB, RGBW, RGBCW

Veja o vídeo
explicativo →





PERFIS FLEXÍVEIS
E
ACESSÓRIOS

WWW.BIOLUCCI.COM.BR

Perfis Flexíveis de Silicone já com a Fita de Led instalada
IDEAL PARA MARCENARIA

Tensão
24V

IP20

2 ANOS
DE GARANTIA

Corte onde quiser

PERFIL FLEXÍVEL
EMBUTIR

PERFIL SL-07

Cód. 90

ESPECIFICAÇÕES DA FITA

- **POTÊNCIA:** 8W/m
- **VOLTAGEM:** 24V
- **TEMPERATURA:** 3000k
- **LEDS/m:** 120
- **LUMENS:** 417 Lm/m
- **POSIÇÃO:** Horizontal

PERFIL SL-08

Cód. 89

ESPECIFICAÇÕES DA FITA

- **POTÊNCIA:** 8W/m
- **VOLTAGEM:** 24V
- **TEMPERATURA:** 4000k
- **LEDS/m:** 120
- **LUMENS:** 435 Lm/m
- **POSIÇÃO:** Horizontal

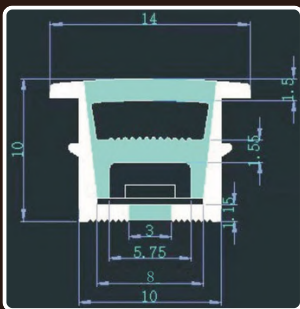
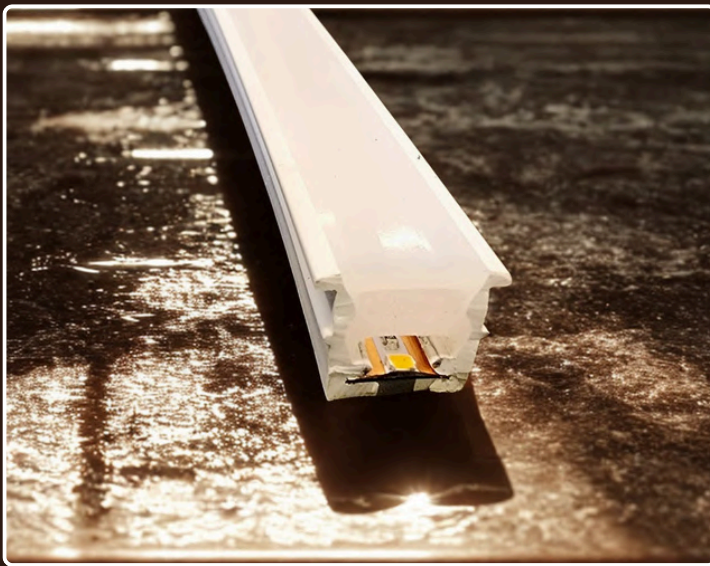

Altura - 10mm
Largura - 10mm



Linha de
Drivers para
Marcenaria
Pág. 29



Linha de
Sensores para
Free Cut
Pág. 30



Cabo de
alimentação
Cód. 781



Veja o vídeo
explicativo



Veja o vídeo
de instalação

Perfis Flexíveis de Silicone já com a Fita de Led instalada
IDEAL PARA MARCENARIA

Tensão
24V

IP20

2 ANOS
DE GARANTIA

Corte onde quiser

PERFIL FLEXÍVEL EMBUTIR

PERFIL SL-09

Cód. 87

ESPECIFICAÇÕES DA FITA

- **POTÊNCIA:** 8W/m
- **VOLTAGEM:** 24V
- **TEMPERATURA:** 3000k
- **LEDS/m:** 120
- **LUMENS:** 412 Lm/m
- **POSIÇÃO:** Horizontal

PERFIL SL-10

Cód. 91

ESPECIFICAÇÕES DA FITA

- **POTÊNCIA:** 8W/m
- **VOLTAGEM:** 24V
- **TEMPERATURA:** 4000k
- **LEDS/m:** 120
- **LUMENS:** 424 Lm/m
- **POSIÇÃO:** Horizontal

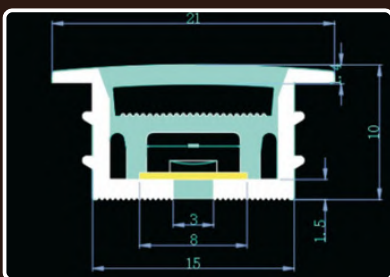
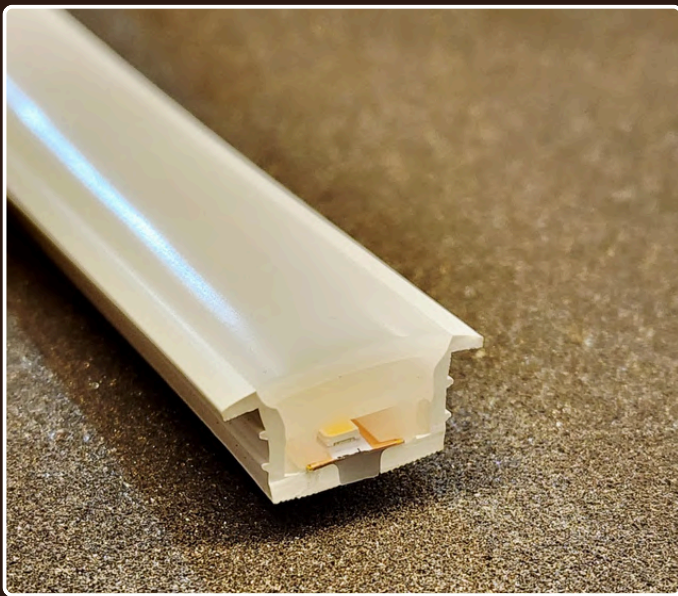

Altura - 10mm
Largura - 15mm



Linha de Drivers para Marcenaria
Pág. 29



Linha de Sensores para Free Cut
Pág. 30



Cabo de alimentação
Cód. 781

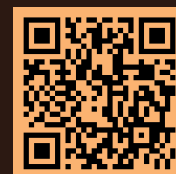

Veja o vídeo explicativo ↑



Veja o vídeo de instalação ↑

Perfis Flexíveis de Silicone já com a Fita de Led instalada
IDEAL PARA MARCENARIA

Tensão
24v

IP20

2 ANOS
DE GARANTIA

Corte onde quiser

PERFIL FLEXÍVEL
EMBUTIR

PERFIL SL-11

Cód. 88

ESPECIFICAÇÕES DA FITA

- **POTÊNCIA:** 8W/m
- **VOLTAGEM:** 24V
- **TEMPERATURA:** 3000k
- **LEDS/m:** 120
- **LUMENS:** 432 Lm/m
- **POSIÇÃO:** Horizontal

PERFIL SL-12

Cód. 92

ESPECIFICAÇÕES DA FITA

- **POTENCIA:** 8W/m
- **VOLTAGEM:** 24V
- **TEMPERATURA:** 4000k
- **LEDS/m:** 120
- **LUMENS:** 439 Lm/m
- **POSIÇÃO:** Horizontal

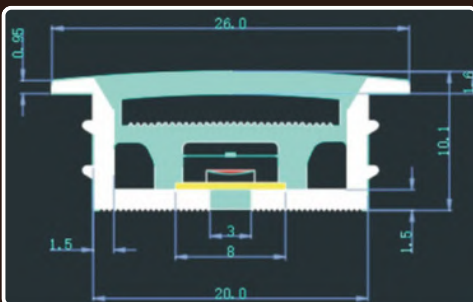

Altura
10mm
Largura
20mm



Linha de Drivers para Marcenaria
Pág. 29



Linha de Sensores para Free Cut
Pág. 30



Cabo de alimentação
Cód. 781



Veja o vídeo explicativo ↑



Veja o vídeo de instalação ↑

Perfis Flexíveis de Silicone já com a Fita de Led instalada
IDEAL PARA MARCENARIA

Tensão
24v

IP20

2 ANOS
DE GARANTIA

Corte onde quiser

PERFIL FLEXÍVEL
SOBREPOR PRETO

PERFIL TODO PRETO

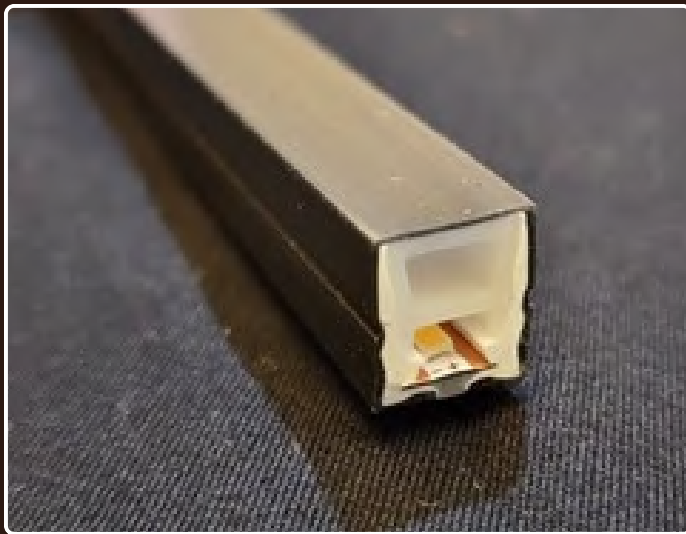

PERFIL SL-13
Cód. 93

ESPECIFICAÇÕES DA FITA

- **POTÊNCIA:** 8W/m
- **VOLTAGEM:** 24V
- **TEMPERATURA:** 3000k
- **LEDS/m:** 120
- **LUMENS:** 51 Lm/m
- **POSIÇÃO:** Horizontal

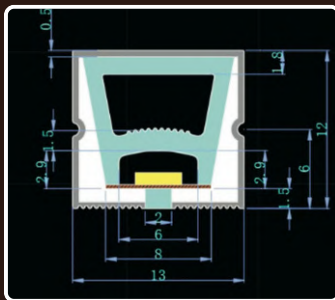

Altura - 12mm
Largura - 13mm



Linha de
Drivers para
Marcenaria
Pág. 29

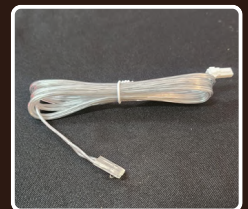

Cabo de
alimentação
Cód. 781



Linha de
Sensores para
Free Cut
Pág. 30

IDEAL PARA MARCENARIA

Tensão
24v

IP20

2 ANOS
DE GARANTIA

DRIVERS DE MARCENARIA 24V - IP20



Driver Marcenaria 6 Saídas 36W

Cód. 60

Dimensões: 136x54x18mm



Driver Marcenaria 6 Saídas 60W

Cód. 61

Dimensões: 170x60x20mm

Driver Marcenaria 10 Saídas 100W

Cód. 62

Dimensões: 200x60x20mm

ACESSÓRIOS PARA FREE CUT



Conjunto de
junção de
6 Saídas
Cód. 94



Conjunto de
junção de
10 Saídas
Cód. 95



Cabo de
Alimentação
1,80 metros
Cód. 781

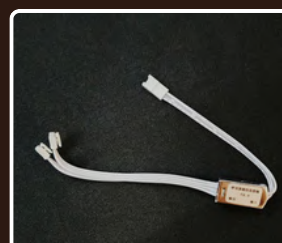

Amplificador de
Drivers Para uso
de sensor
Cód. 778



Conector de sensor
para conjunto
de junção
Cód. 63

Veja o vídeo
explicativo



IDEAL PARA USO COM
DRIVERS DE MARCENARIA

Tensão ⚡
12v/24v

2 ANOS
DE GARANTIA



Sensor Touch
e Dimerizável
Cód. 779

Veja o vídeo
explicativo



Sensor de Movimento
das Mãos
e Dimerizável
Cód. 64

Veja o vídeo
explicativo



Sensor de Movimento
do Corpo
Cód. 65

Veja o vídeo
explicativo



Sensor de Presença
Cód. 68

Veja o vídeo
explicativo



Sensor para uma Porta
Cód. 66

Veja o vídeo
explicativo



Sensor para duas Portas
Cód. 67

Veja o vídeo
explicativo



SÉRIE SILICONE FLEXÍVEL COM FITA JÁ EMBUTIDA

ACESSE NOSSO SITE
BIOLUCCI.COM.BR

36

Perfis Flexíveis de Silicone já com a Fita de Led instalada
IDEAL PARA ÁREA INTERNA OU EXTERNA

Tensão
24v

IP65

2 ANOS
DE GARANTIA

PERFIL FLEXÍVEL SOBREPOR

PERFIL SL-02

Cód. 763



ESPECIFICAÇÕES

- **POTÊNCIA:** 12W/m
- **VOLTAGEM:** 24V
- **TEMPERATURA:** 3000k
- **LEDS/m:** 128
- **LUMENS:** 770 Lm/m
- **POSIÇÃO:** Horizontal

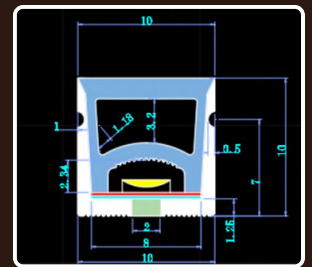

Altura - 10mm
Largura - 10mm



Clipe para
fixação
do Perfil
Cód. 390



Ponteira para
vedação do
Perfil
Cód. 232

Corte a cada 6,0cm

PERFIL SL-04

Cód. 765

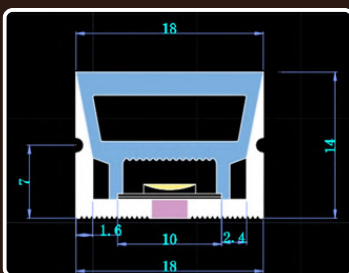

Altura - 14mm
Largura - 18mm

ESPECIFICAÇÕES DA FITA

- **POTÊNCIA:** 12W/m
- **VOLTAGEM:** 24V
- **TEMPERATURA:** 3000k
- **LEDS/m:** 128
- **LUMENS:** 770 Lm/m
- **POSIÇÃO:** Horizontal



Clipe para
fixação
do Perfil
Cód. 780

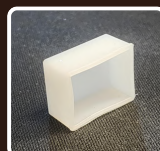

Ponteira para
fixação do
Perfil
Cód. 238

Corte a cada 6,0cm



Veja o vídeo
explicativo



Veja o vídeo
de instalação

SÉRIE SILICONE FLEXÍVEL COM FITA JÁ EMBUTIDA

ACESSE NOSSO SITE
BIOLUCCI.COM.BR

37

Perfis Flexíveis de Silicone já com a Fita de Led instalada
IDEAL PARA ÁREA INTERNA OU EXTERNA

Tensão
24v

IP65

2 ANOS
DE GARANTIA

PERFIL FLEXÍVEL EMBURIR



PERFIL SL-03

Cód. 764

ESPECIFICAÇÕES

- **POTÊNCIA:** 10W/m
- **VOLTAGEM:** 24V
- **TEMPERATURA:** 3000k
- **LEDS/m:** 128
- **LUMENS:** 600 Lm/m
- **POSIÇÃO:** Vertical

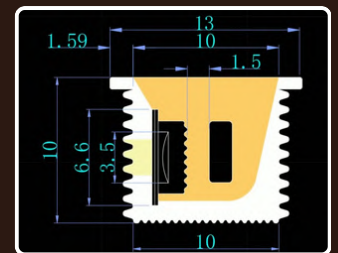

Altura - 10mm
Largura - 10mm

Corte a cada 6,0cm



Ponteira para
vedação do Perfil
Cód. 232

PERFIL SL-05

Cód. 767

ESPECIFICAÇÕES

- **POTÊNCIA:** 12W/m
- **VOLTAGEM:** 24V
- **TEMPERATURA:** 3000k
- **LEDS/m:** 128
- **LUMENS:** 580 Lm/m
- **POSIÇÃO:** Vertical

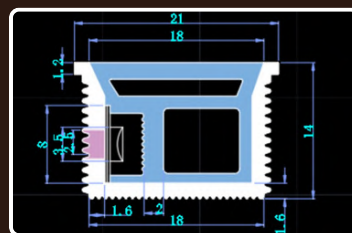

Altura - 14mm
Largura - 18mm



Corte a cada 6,0cm

Ponteira para
vedação do Perfil
Cód. 238

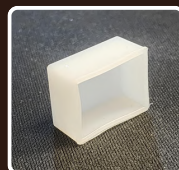

Veja o vídeo
explicativo



Veja o vídeo
de instalação



SÉRIE SILICONE FLEXÍVEL COM FITA JÁ EMBUTIDA

ACESSE NOSSO SITE
BIOLUCCI.COM.BR

38

Perfis Flexíveis de Silicone já com a Fita de Led instalada
APENAS PARA ÁREA EXTERNA

Tensão
48v ⚡

IP65

2 ANOS
DE GARANTIA

Pode ser ligado segmentos de até 50m
contínuos sem perda de lumens.

**PERFIL FLEXÍVEL
SOBREPOR**

PERFIL SL-06

Cód. 770



ESPECIFICAÇÕES

POTÊNCIA: 12W/m
VOLTAGEM: 48V
TEMPERATURA: 3000k
LEDS/m: 120
LUMENS: 820 Lm/m
POSIÇÃO: Horizontal

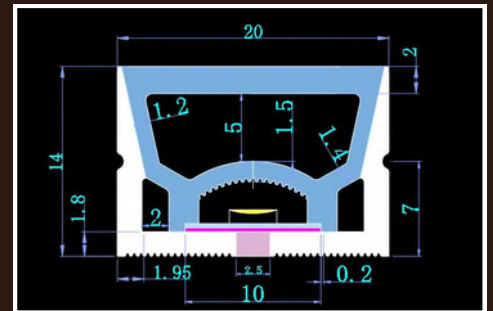

Altura - 14mm

Largura - 20mm

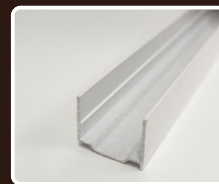

Perfil 3m para
fixação
Cód. 771 e 772

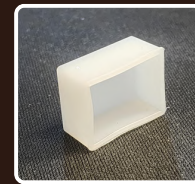

Ponteira para
vedação do Perfil
Cód. 238



**Veja o vídeo
explicativo** ↑

✂ Corte a cada 6,0cm

Use as Fontes 48V Biolucci

Pág. 21

5 à 10 metros - Fonte 100W

11 à 15 metros - Fonte 150W

16 à 25 metros - Fonte 250W

30 à 50 m - 2 Fontes 250W

PROJETOS ORGÂNICOS



Perfis Flexíveis de Silicone para Fitas de Led 12V e 24V
APENAS PARA ÁREA INTERNA

**ROLOS
100M**

IP65

**2 ANOS
DE GARANTIA**

**IDEAL PARA USO DE QUALQUER FITA
LED DE 8 À 10MM IP20 12V OU 24V**

**PERFIL FLEXÍVEL
EMBUTIR**

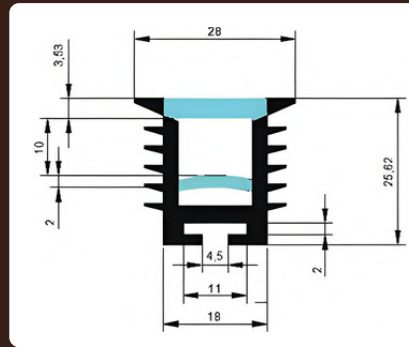
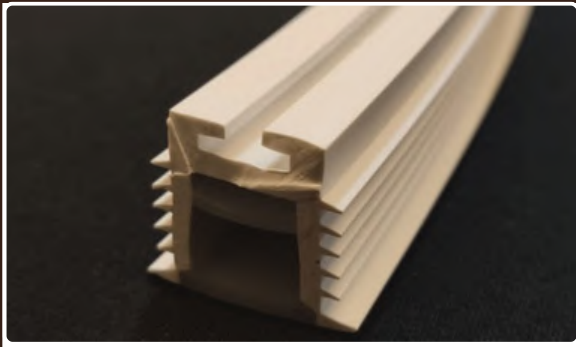

**Altura - 25,62mm
Largura - 18mm**

**PTL 2826K
Cód. 381**

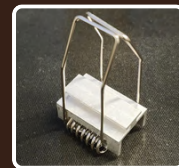

Clipe de mola
fixação do Perfil
Cód. 395

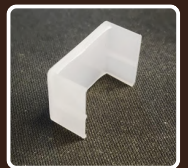

Ponteira para
vedação do Perfil
Cód. 382

**PTL T2220M
Cód. 402**

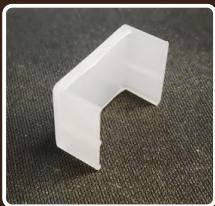

Ponteira para
vedação do Perfil
Cód. 403

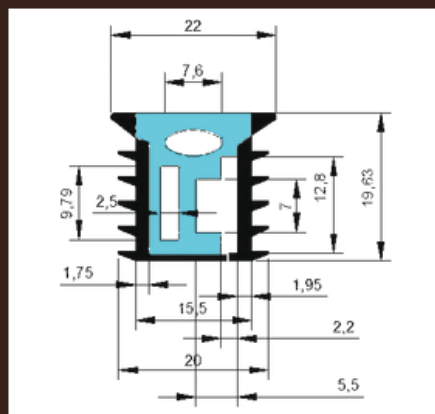

**Altura - 19,63mm
Largura - 20mm**

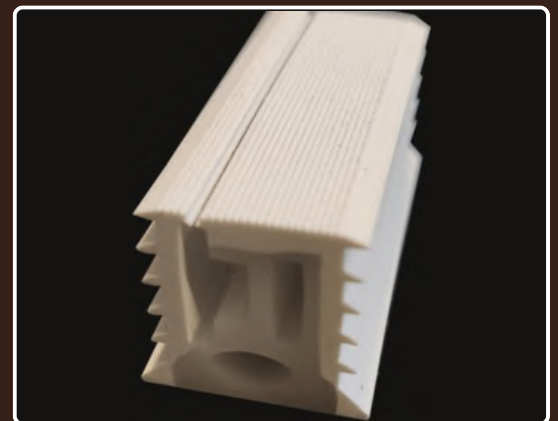

**Veja o vídeo
explicativo**



Alta qualidade de silicone, resistente ao tempo e radiação,
resistência de temperaturas entre -40°C e $+120^{\circ}\text{C}$.

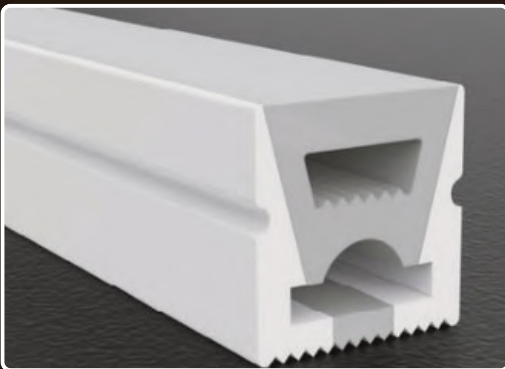

Para uso com fitas de
4mm de largura.
Fita colocada na **horizontal**

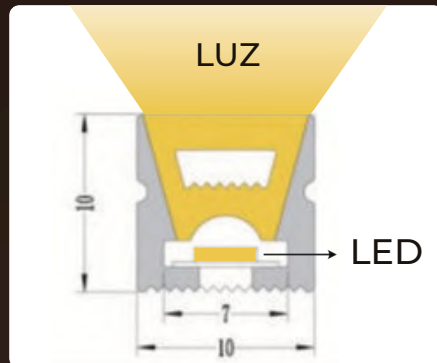

Altura - 10mm
Largura - 10mm

PTL-1010A

Cód. 231



Clipe para
fixação do Perfil
Cód. 390

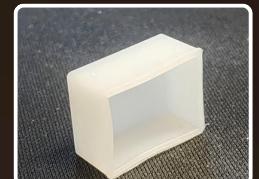

Ponteira para
vedação do Perfil
Cód. 232



PTL-1616B

Cód. 234



Ponteira para
vedação do Perfil
Cód. 235



Clipe para
fixação do Perfil
Cód. 391

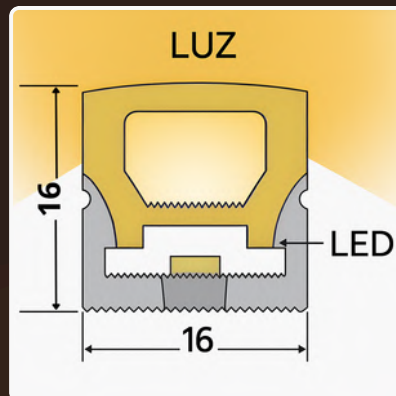

Altura - 16mm
Largura - 16mm

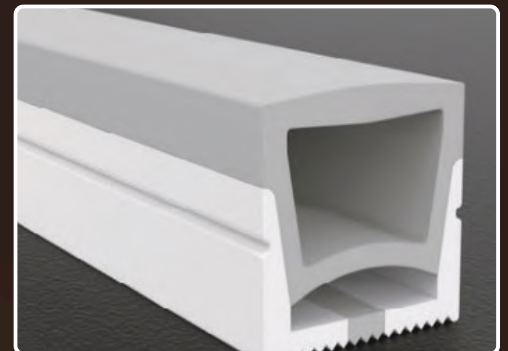

Para uso com fitas de **10mm de largura.**
Fita colocada na **horizontal.**



Para uso com fitas de
10mm de largura.
Fita colocada na **horizontal.**

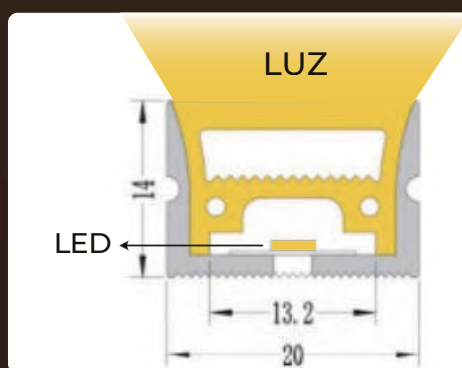

Altura - 14mm
Largura - 20mm

PTL-2014A

Cód. 237

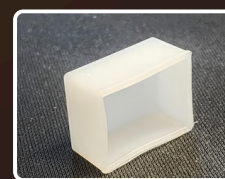

Ponteira para
vedação do Perfil
Cód. 238



Clipe para
fixação do Perfil
Cód. 392

PTL-C1616
Cód. 241

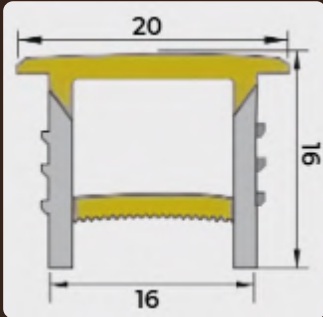

Altura - 16mm
Largura - 16mm



Para uso com fitas de **10mm de largura**.
Fita colocada na **horizontal**.

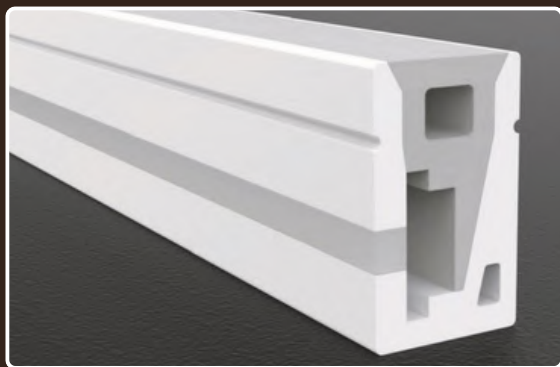

Para uso com fitas de **10mm de largura**.
Fita colocada na **vertical**.

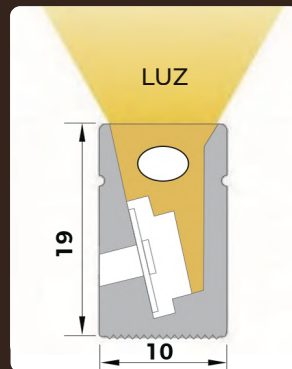

Altura - 19mm
Largura - 10mm

PTL-T1019C
Cód. 359



Ponteira para
vedação do Perfil
Cód. 360



Clipe para
fixação do Perfil
Cód. 393

PTL-T1616C
Cód. 356

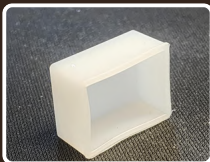

Ponteira para
vedação do Perfil
Cód. 357



Clipe para
fixação do Perfil
Cód. 394

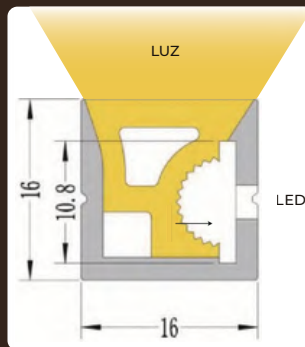

Altura - 16mm
Largura - 16mm

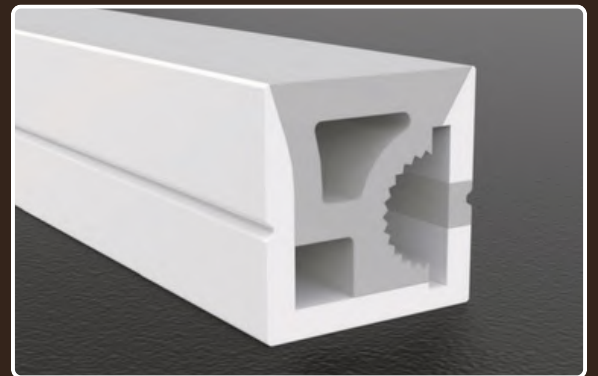

Para uso com fitas de **10mm de largura**.
Fita colocada na **vertical**.



Para uso com fitas de **10mm de largura**.
Fita colocada na **vertical**.

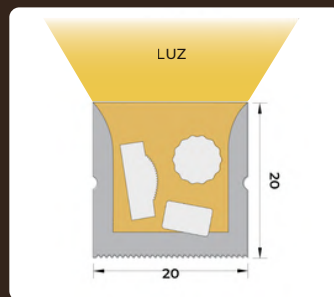

Altura - 19mm
Largura - 10mm

PTL-T2020D
Cód. 107



Veja o vídeo
explicativo

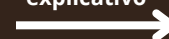



PERFIS ALUMÍNIO E ACESSÓRIOS

WWW.BIOLUCCI.COM.BR

PERFIS

SÉRIE ALUMÍNIO FLEXÍVEL

Perfis Flexíveis para teto e parede com lente de silicone.
APENAS PARA ÁREA INTERNA

PEF 1913

Cód. 379

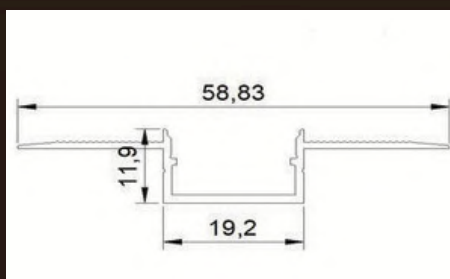
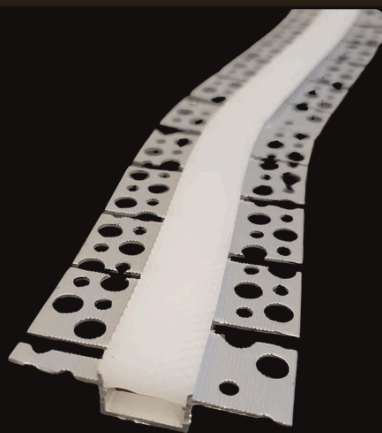

Para uso com fita de 10mm

Veja o vídeo
explicativo



PEF 1313

Cód. 380

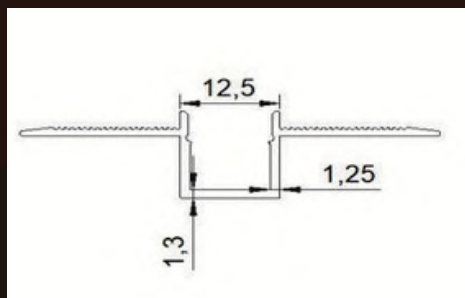

Para uso com fita 8 ou 4mm



SÉRIE LIGHT

SO-1

Cód. 664

Perfil de Sobrepor

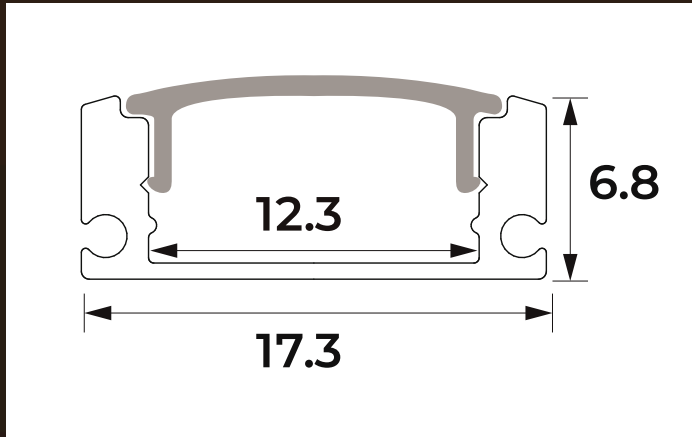

Clipe de Fixação



Conector - 90 graus



Conector - 180 graus



Ponteira



COR : BRANCO E PRETO

EM-1

Cód. 674

Perfil de Embutir

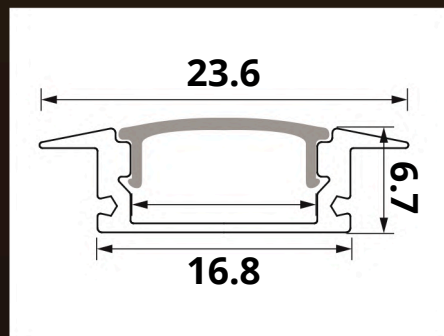

Ponteira



Clipe de Montagem de Plástico





SO-4
Cód. 709

Perfil de Sobrepor

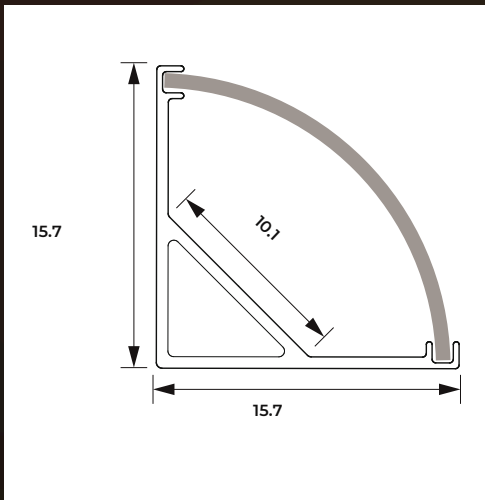

COR : BRANCO E PRETO

Clipe de Montagem



Conector 90 Graus



Conector 180 Graus



Ponteira



SO-5
Cód. 749



Perfil de Sobrepor

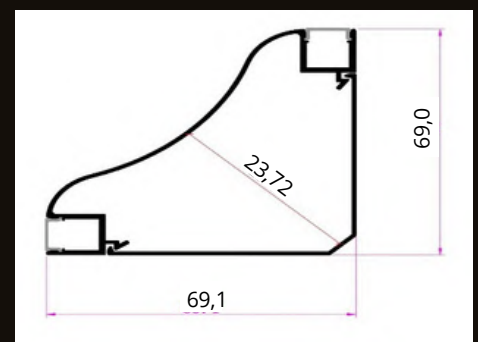

COR : BRANCO

Ponteira

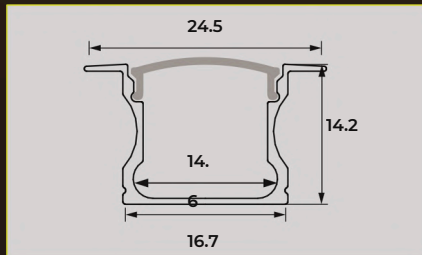
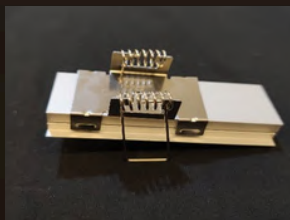
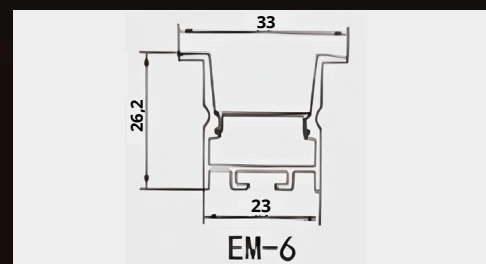

EM-03**Cód. 683****Perfil para Embutir****Clipe de
Fixação****Clipe de
Fixação Geral
Médio****Ponteira****COR : BRANCO E PRETO****EM-6****Cód. 866****Perfil para Embutir****Ponteira****Clipe de Mola****COR : BRANCO**

EM-7
Cód. 101

Perfil de Embutir

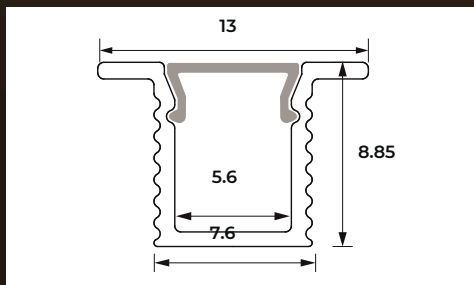

Ponteira



Clip de Montagem



USAR COM FITAS DE 4MM
DE LARGURA.

COR : BRANCO E PRETO

SO-7
Cód. 102

Perfil para Sobrepor

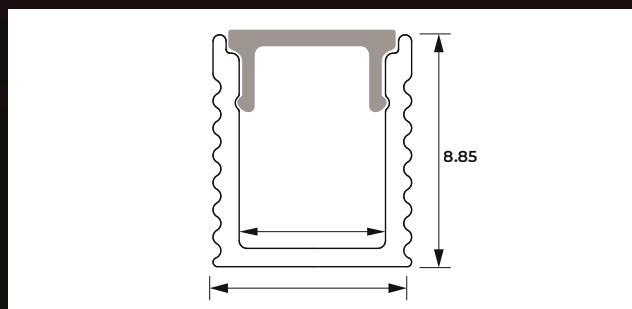

Ponteira



Clip de Montagem
de Metal



USAR COM FITAS DE 4MM DE
LARGURA.

SO-2

Cód. 691

Perfil de Sobrepor

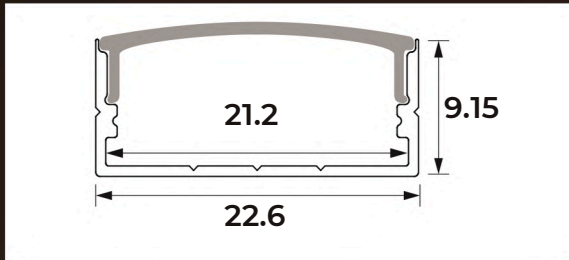

Ponteira



Clipe de Plástico

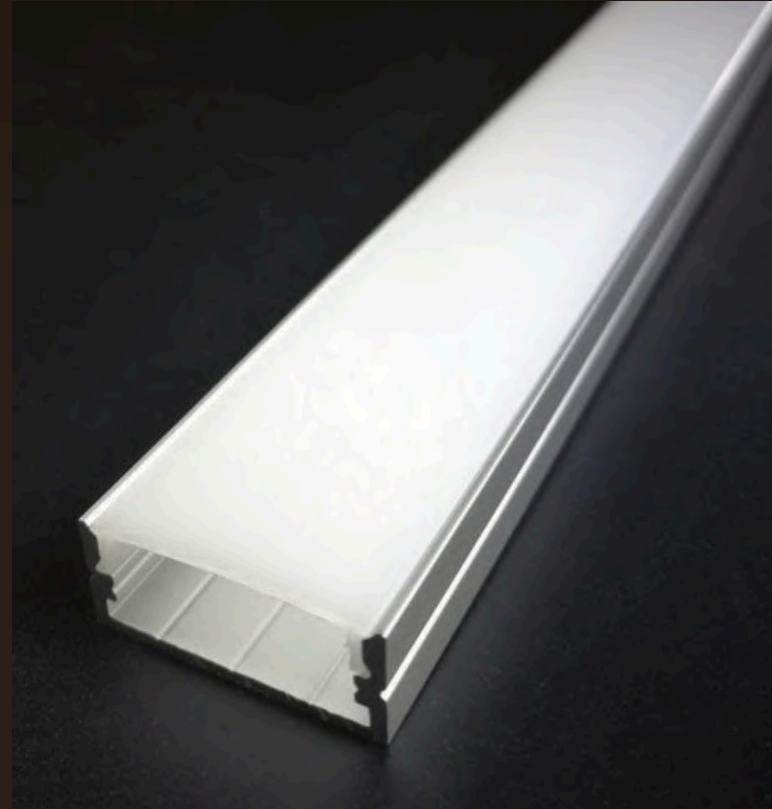

COR : BRANCO E PRETO

EM-2

Cód. 705

Perfil para Embutir

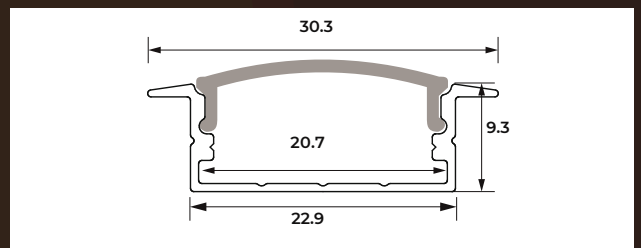
Clipe de Montagem
de Plástico

Ponteira

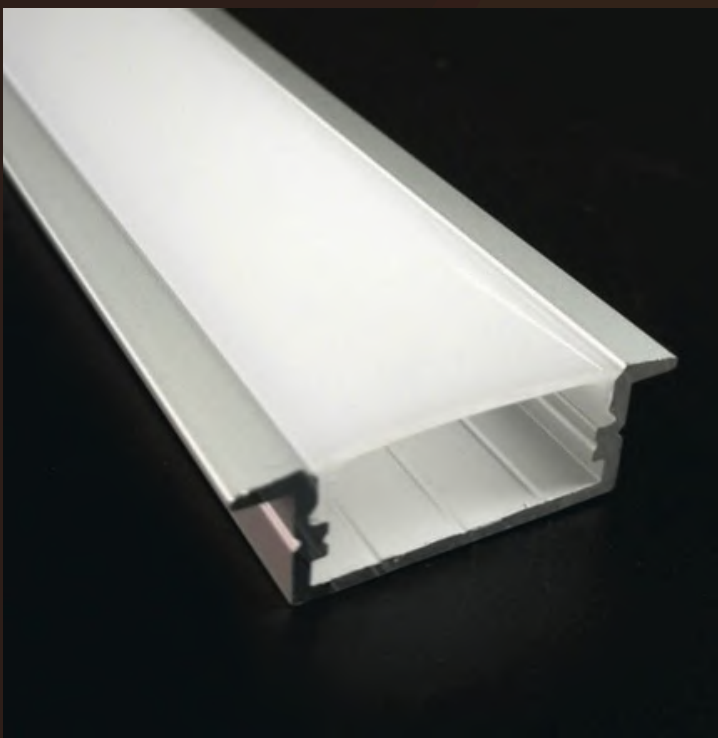

SP-2
Cód. 869

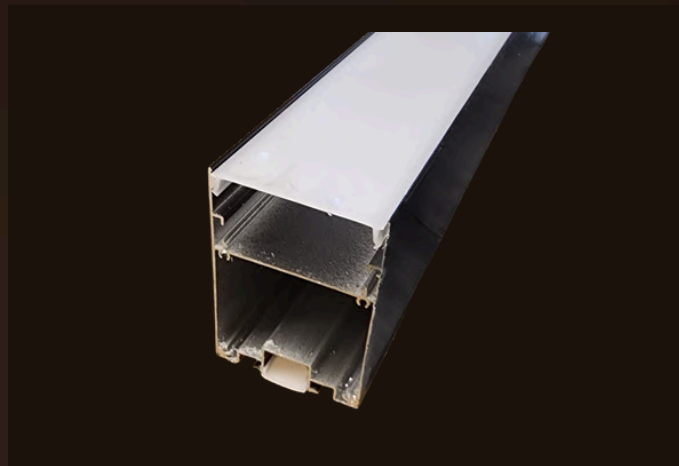
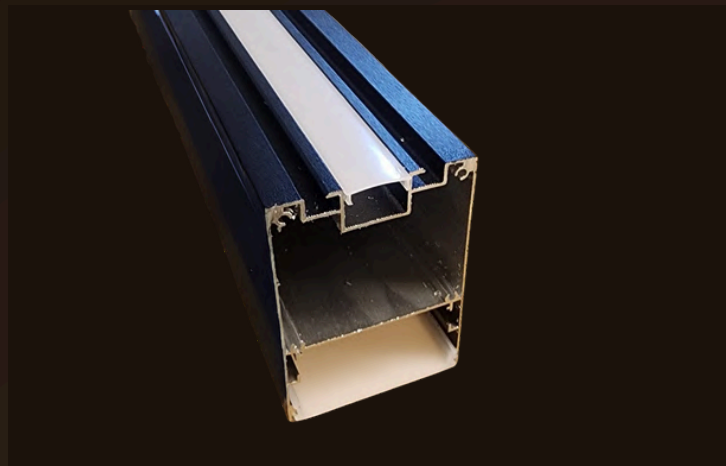

COR : BRANCO E PRETO

DIMENSÕES

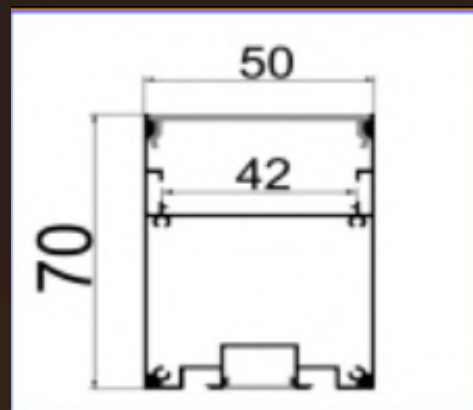

PONTEIRA



SÉRIE POWERLINE

EM-35

Cód. 103

Perfil para Embutir

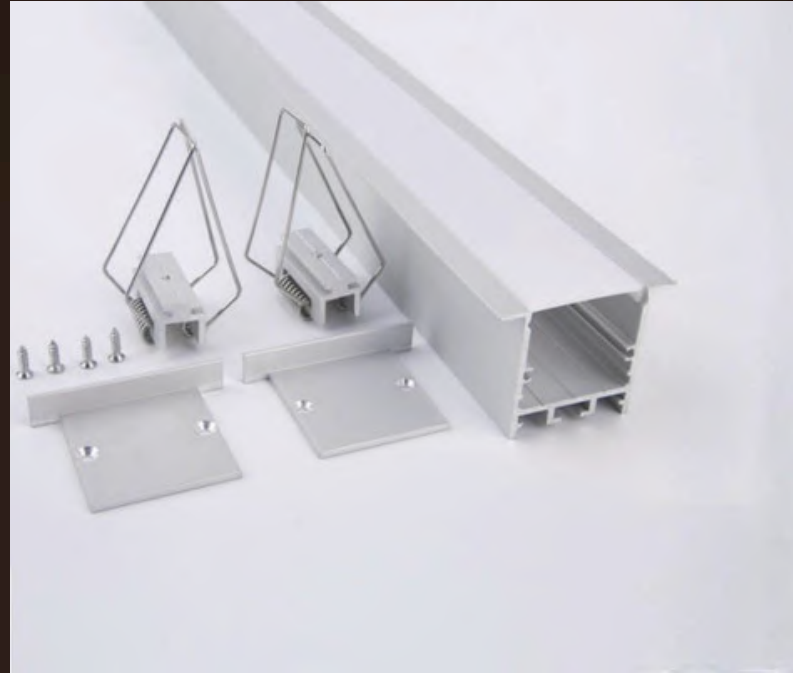
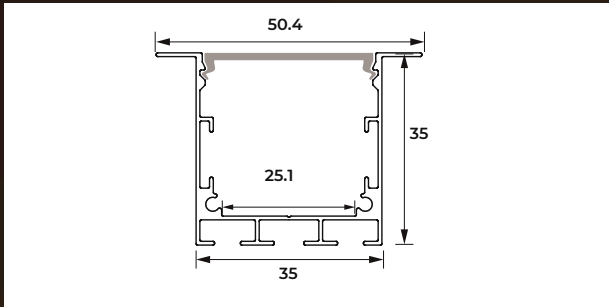

Ponteira



**Conector 90 Graus A
(Horizontal)**



**Conector 90 Graus B
(Vertical)**

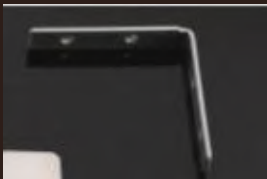

Conector 180 Graus C

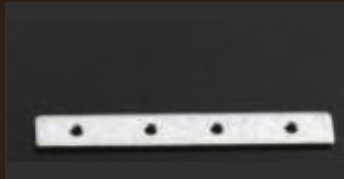

Clipe de Mola

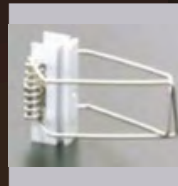

COR : BRANCO E PRETO

SO-35

Cód. 859



Perfil de Sobrepor

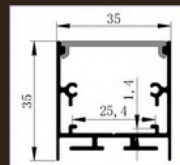

**Conector 90
Graus B (Horizontal)**



Clip de Metal



**Conector 90
Graus A (Vertical)**



Ponteira - Comum e Preta



Conector 180 Graus A

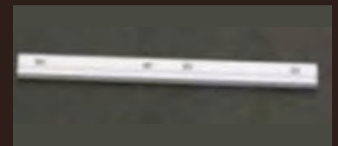

Kit de Suspensão

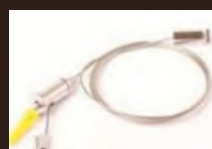

COR : BRANCO E PRETO

PS-4025

Cód. 281

Perfil - Pendente
para 2 fitas de 10mm

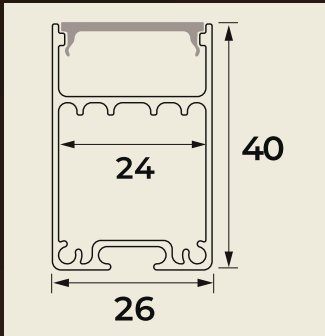

Kit de Suspensão



Ponteira



Específico para usar
como pendente.

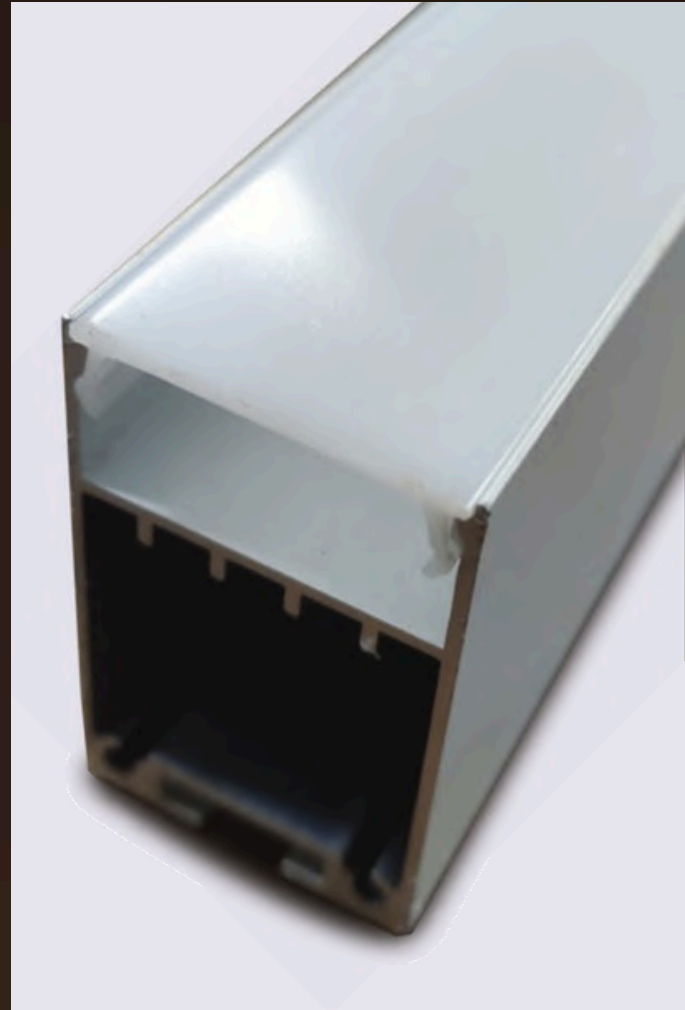

COR: ANODIZADO, BRANCO E PRETO

SP-1

Cód. 745

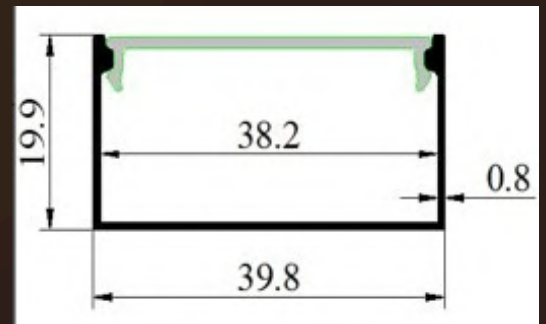

COR : BRANCO E PRETO

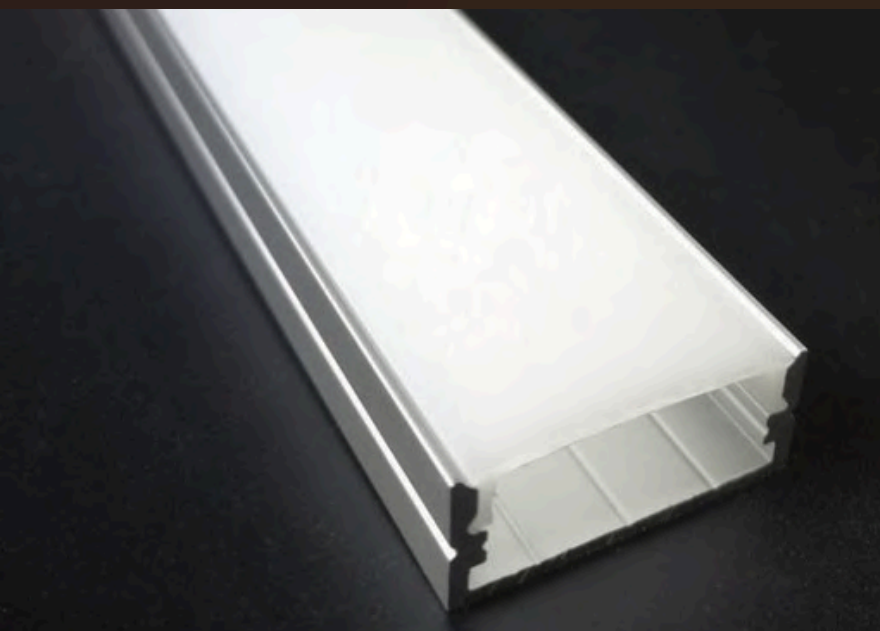

SÉRIE NO FRAME

EM-37
Cód.105

Emenda para
curva de 90° graus

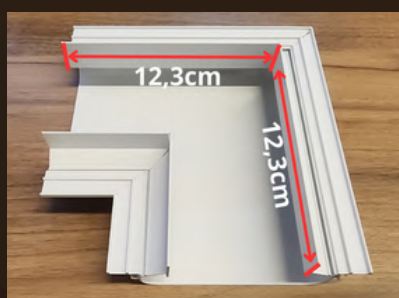

Ponteira

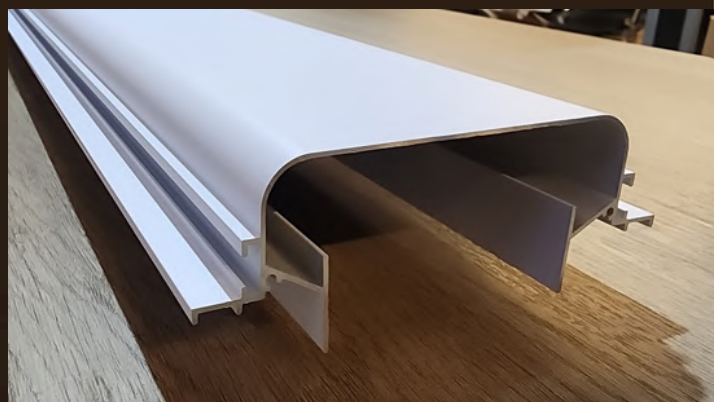
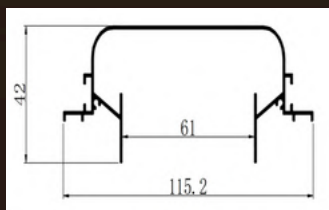

COR : BRANCO

PNF-16
Cód. 278

Ponteira

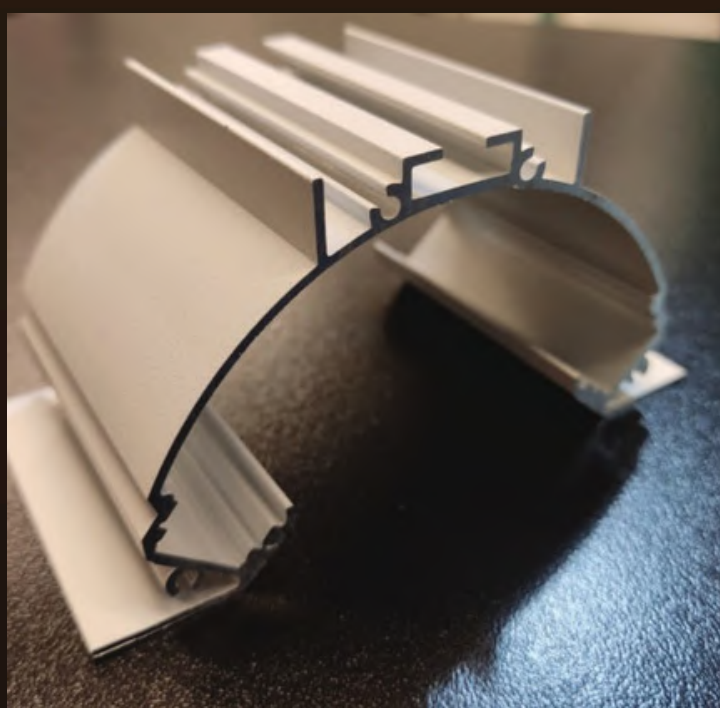
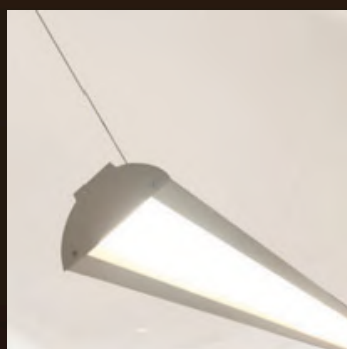
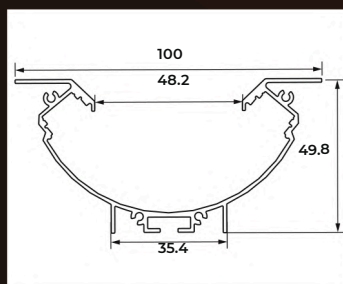

COR : BRANCO



SO-50
Cód. 106

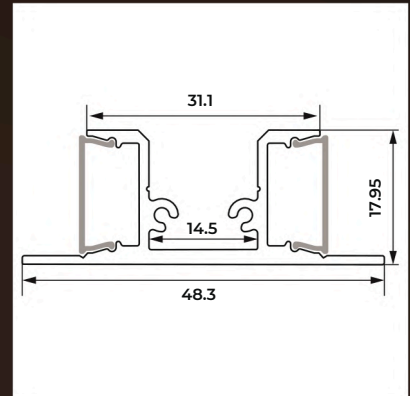

Clipe

COR : BRANCO E PRETO

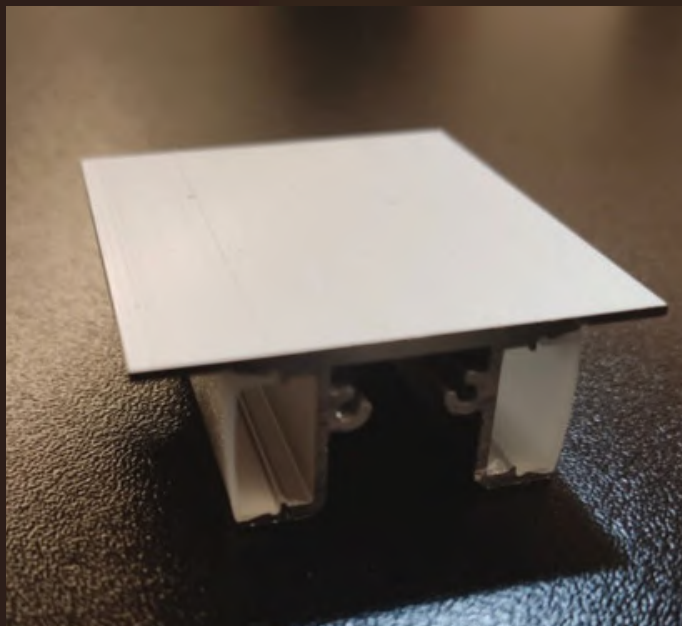

Ponteira



PENDENDES E LUSTRES

WWW.BIOLUCCI.COM.BR

LUSTRES, PLAFONS E PENDENTES

LF 88055 TRANSPARENTE

Cód. 5

MATERIAL: METAL - VIDRO - CRISTAL

COR TRANSPARENTE

DIÂMETRO

50CM

ALTURA

45CM

LÂMPADA

08 E14



LF 8527

Cód. 465

MATERIAL: METAL - VIDRO - CRISTAL

COR TRANSPARENTE

DIÂMETRO

30CM

ALTURA

13,5CM

LÂMPADA

2 E14





LF 85807 PLAFON

Cód. 853

DIMENSÕES
50CM X 50CM

ALTURA
8CM

LED INTEGRADO

84W-3000K



LF 85097-L4 PLAFON

Cód. 854



DIMENSÕES
53CM X 53CM

ALTURA
4,5CM

LED INTEGRADO

96W-3000K



LF 86310-SQU PLAFON

Cód. 855

DIMENSÕES
52CM X 52CM

ALTURA
8CM

LED INTEGRADO

78W-3000K

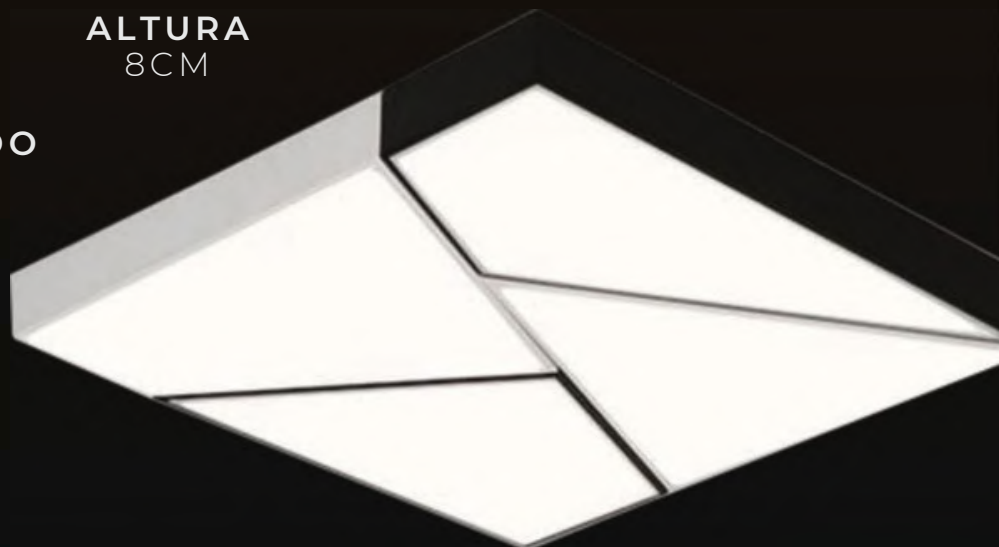

LF 85806 PLAFON
Cód. 852

DIMENSÕES
50CM X 50CM

ALTURA
6CM

LED INTEGRADO
66W-3000K



LF 82041
Cód. 2896

MATERIAL: ACRÍLICO - ALUMÍNIO

**COR BRANCO FOSCO E
LENTE LEITOSA**

DIMENSÕES

60CM X 40CM

ALTURA COM O CABO

100CM

LED INTEGRADO BIVOLT
31W-3000K

LF 5060 B 1R
Cód. 45

MATERIAL: ACRÍLICO - ALUMÍNIO

COR OLD GOLD E BRANCO FOSCO

DIÂMETRO ALTURA
20CM 100CM

LED INTEGRADO BIVOLT
19W-3000K





LF 81489 L3

Cód. 43



MATERIAL: ACRÍLICO - METAL

COR ALUMÍNIO E BRANCO FOSCO

DIÂMETRO ALTURA

47CM

10CM

LED INTEGRADO BIVOLT

21W-3000K

LF 2102
Cód. 410

MATERIAL: ACRÍLICO - CRISTAL

COR TRANSPARENTE
E ESPELHADO

DIÂMETRO ALTURA C/ CABO

55CM

100CM

LED INTEGRADO BIVOLT

35W-3000K

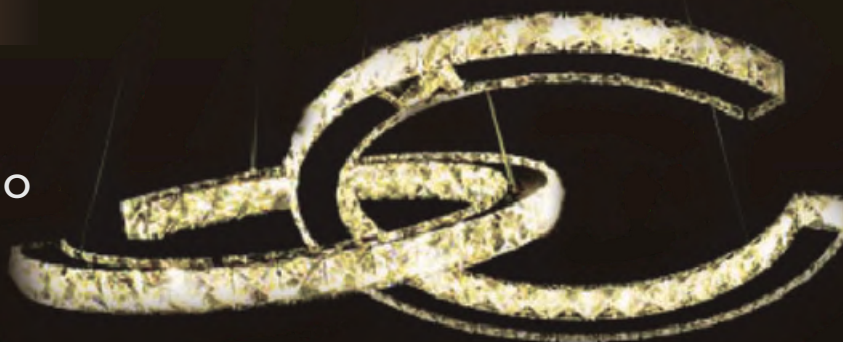

LF 81087

Cód. 2023



MATERIAL: ACRÍLICO - METAL

COR LENTE LEITOSA E
BRANCO FOSCO

DIMENSÕES

74CM/45CM

ALTURA C/ CABO

100CM

LED INTEGRADO BIVOLT

52W-3000K



LF 87544
Cód. 502

MATERIAL: METAL - ACRÍLICO

COR PRETO

DIMENSÕES

85X38 / 52X28 / 75X33 CM

DIMENSÕES DA CANOPLA

46X42 CM

COMPRIMENTO DO CABO

120 CM

LED INTEGRADO BIVOLT

63W-3000K



LF 5026 4R
Cód. 831

MATERIAL: AÇO - INOX E ACRÍLICO

OURO 24K

DIÂMETRO

80/60/40/20 CM

ALTURA DO CABO

150CM

LED INTEGRADO BIVOLT

67W-3000K



LF 81927 1R

MATERIAL: ACRÍLICO - METAL



OLD GOLD
Cód. 824



ROSÉ
Cód. 823



BRANCO
Cód. 821

DIÂMETRO ALTURA

60CM 120CM

LED INTEGRADO BIVOLT

20W-3000K





LF 81927 2R



MATERIAL: ACRÍLICO - METAL

OLD GOLD
Cód. 819ROSÉ
Cód. 817BRANCO
Cód. 816

DIÂMETRO ALTURA

60/40CM 120CM

LED INTEGRADO BIVOLT

32W-3000K

LF 81927 3R

MATERIAL: ACRÍLICO - METAL

OLD GOLD
Cód. 829ROSÉ
Cód. 827PRETO
Cód. 828

DIÂMETRO ALTURA

80/60/40CM 120CM

LED INTEGRADO BIVOLT

67W-3000K



LF 81927 4R 80

MATERIAL: ACRÍLICO - METAL

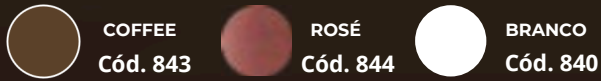

DIÂMETRO 80/60/40/20 CM ALTURA 150CM

LED INTEGRADO BIVOLT
67W-3000K



LF 81927 4R 100

MATERIAL: ACRÍLICO - METAL



DIÂMETRO 100/80/60/40CM ALTURA 150CM

LED INTEGRADO BIVOLT
32W-3000K



LF 81927 5R

MATERIAL: ACRÍLICO - METAL



DIÂMETRO 100/80/60/40/20 CM ALTURA 150CM

LED INTEGRADO BIVOLT
67W-3000K





LF 86420-50

MATERIAL: METAL - POLICARBONATO



OLD GOLD
Cód. 814

DIÂMETRO ALTURA
50CM 120CM

LED INTEGRADO BIVOLT
28W-3000K



LF 86420-70

MATERIAL: METAL - POLICARBONATO



OLD GOLD
Cód. 815



BRANCO
Cód. 813

DIÂMETRO ALTURA
70CM 120CM

LED INTEGRADO BIVOLT
38W-3000K

LF 81035
Cód. 51

MATERIAL: **ACRÍLICO - METAL**

COR BRANCO FOSCO

COMPRIMENTO ALTURA
100 CM **C/ CABO**
100CM

LED INTEGRADO 3 CORES COM
CONTROLE REMOTO
12W-3000K/4000K/6000K



LF 8825 2R
Cód. 417

MATERIAL: **ACRÍLICO - CRISTAL**

COR TRANSPARENTE E ESPELHADO

DIÂMETRO
50CM / 30CM

ALTURA COM O CABO
120 CM

LED INTEGRADO BIVOLT
30W-3000K



LF 8825 4R
Cód. 431

MATERIAL: **ACRÍLICO - CRISTAL**

COR TRANSPARENTE E ESPELHADO

DIMENSÕES
100CM/80CM/60CM/40CM
ALTURA COM O CABO
3M

LED INTEGRADO BIVOLT
95W-3000K



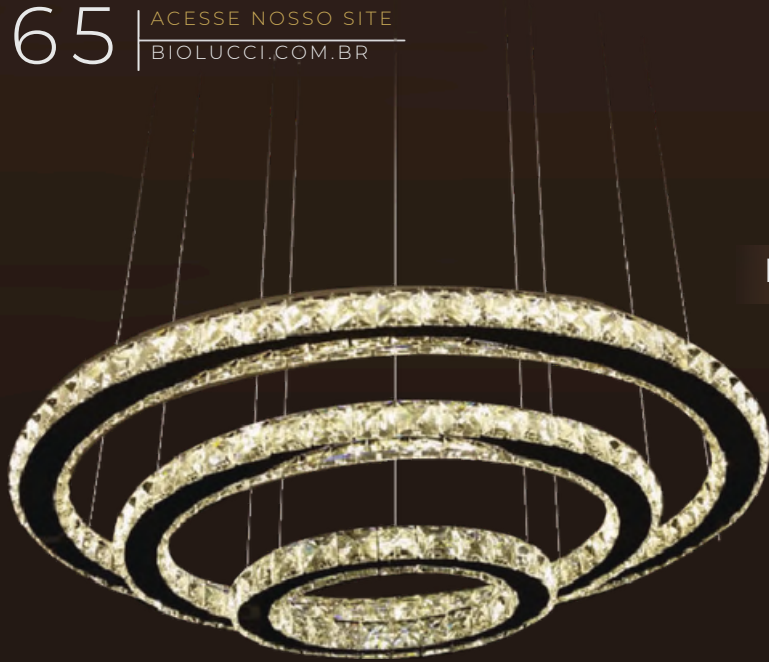

LF 8825 3R LARGE
Cód. 430

MATERIAL: **ACRÍLICO - CRISTAL**

COR TRANSPARENTE
E ESPELHADO

DIMENSÕES

80CM/60CM/40CM

ALTURA C/ CABO

3M

LED INTEGRADO BIVOLT

68W-3000K

LF 3026
Cód. 50

MATERIAL: **METAL - ACRÍLICO**

COR BRANCO FOSCO E PRETO
NA PARTE CENTRAL

DIMENSÕES

97X11,7CM

ALTURA

C/ CABO
100CM

**LED INTEGRADO 3 CORES COM
CONTROLE REMOTO**

12W-3000K/4000K/6000K

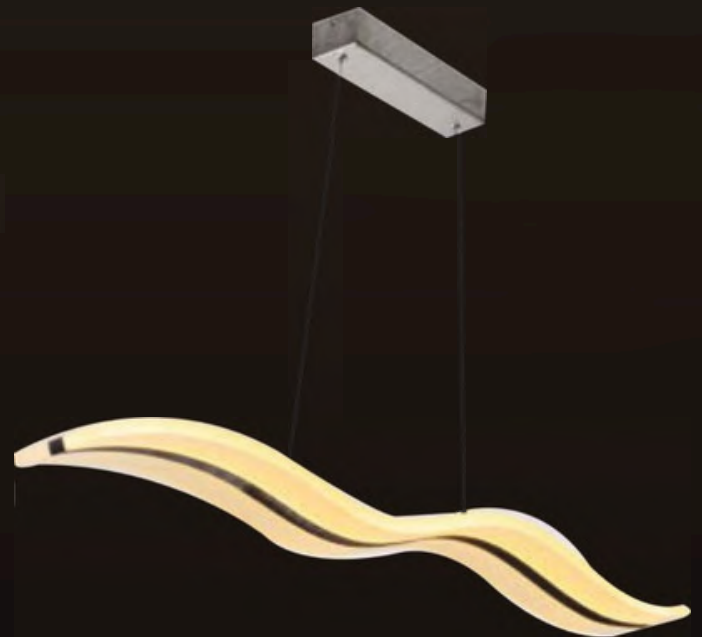

LF 92945

MATERIAL: **ALUMÍNIO - ACRÍLICO**



OLD GOLD
Cód. 851



BRANCO
Cód. 850

DIMENSÕES

68 CM X 28 CM X 4CM

LED INTEGRADO BIVOLT

67W-3000K



LF 83065 3S WHITE

Cód. 820

MATERIAL: METAL - ACRÍLICO

COR BRANCO

LATERAL

70CM/50CM/30CM

LED INTEGRADO BIVOLT

60W - 3000K



LF 83065 2S WHITE

Cód. 506

MATERIAL: METAL - ACRÍLICO

COR BRANCO

LATERAL

50CM/30CM

LED INTEGRADO BIVOLT

32 W - 3000K

LF 83065 1S WHITE

Cód. 507

MATERIAL: METAL - ACRÍLICO

COR BRANCO

LATERAL

30CM

LED INTEGRADO BIVOLT

20 W - 3000K

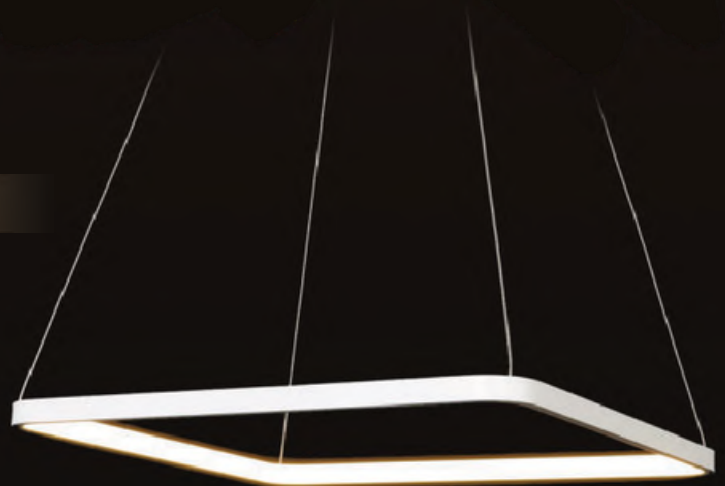

 LF 87543
Cód. 501

MATERIAL: METAL - POLICARBONATO

ALTURA

140CM

CONTROLE REMOTO RGB

14W



LF 85734 
Cód. 503

MATERIAL: METAL - ACRILÍCO

COMPRIMENTO

100CM

LÂMPADAS

20 X G4 3000K JÁ INCLUSAS

 LF 87521
Cód. 504

MATERIAL: METAL - ACRILÍCO

DIMENSÕES

120 X 60 CM

80 X 50 CM

80 X 25 CM

ALTURA DO CABO

120 CM

LED INTEGRADO BIVOLT

83W - 3000K



LF 85552
Cód. 505

MATERIAL: **VIDRO - METAL**

DIÂMETRO
95 CM

ALTURA
80 CM

LÂMPADA
6 X G9 3000K JÁ INCLUSAS

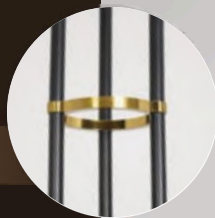

LF 87542
Cód. 500

MATERIAL: **ALUMÍNIO - ACRILÍCO**

DIMENSÕES

40 CM X 62 CM

3 RETÂNGULOS

40 CM / 16 CM

LED INTEGRADO BIVOLT

34W - 3000K



LF 81688 B

Cód. 659



MATERIAL: MADEIRA - ACRÍLICO

DIÂMETRO

40 CM

ALTURA

100CM

LED INTEGRADO BIVOLT

33W-3000K

LF 83009 L1

Cód. 444

MATERIAL: VIDRO



OLDGOLD



ROSÉ GOLD

DIÂMETRO

30 CM

ALTURA

16,5CM

LÂMPADA

1 E27 NÃO INCLUSA



LF 8009 L12

Cód. 2025



MATERIAL: ALUMÍNIO - CRISTAL

COR METAL CROMADO E CRISTAL

DIÂMETRO

50 CM

LÂMPADA

12 X G4 JÁ INCLUSAS





LF 81993 B
Cód. 446



DIMENSÕES
14cm / 19cm



LF 81993 C
Cód. 447



DIMENSÕES
16cm / 22cm

MATERIAL: METAL - VIDRO

COR VIDRO COGNAC E PRETO FOSCO

LÂMPADA 1 E27
NÃO INCLUSA

LF 83008 L1
Cód. 6338

MATERIAL: METAL E ACRÍLICO

COR: DOURADO E TRANSPARENTE

DIÂMETRO
15 CM

ALTURA
20 CM

LÂMPADA
1 G9 INCLUSA

ALTURA COM O CABO
120CM



LF 81772-B
Cód. 448

MATERIAL: METAL

COR METAL ENVELHECIDO

LÂMPADA

1 E27

DIMENSÕES 19 CM /
30CM



LF 81772-C
Cód. 449

MATERIAL: METAL

COR METAL ENVELHECIDO

LÂMPADA

1 E27

DIMENSÕES 24 CM / 17
CM



LF 8885
Cód. 467

MATERIAL: METAL

COR PRETO FOSCO
COR DO CABO VERMELHO

DIÂMETRO 20 CM ALTURA 28CM

LÂMPADA
1 E27
NÃO INCLUSA

LF 83007 L3
Cód. 660

MATERIAL: METAL - ACRÍLICO

COR ROSÉ GOLD

DIÂMETRO

35 CM

LED INTEGRADO

BIVOLT

3 X 9W-3000K

ALTURA DA BASE
ATÉ A EXTREMIDADE
120CM



73

ACESSE NOSSO SITE
BIOLUCCI.COM.BR



LF 3013 L1
Cód. 867

MATERIAL: VIDRO

COR: PRETO E BRANCO

DIÂMETRO
19 CM

ALTURA
12 CM

LÂMPADA
1 E27
NÃO INCLUSA

ALTURA COM
O CABO
100CM



LF 2825
Cód. 2026

MATERIAL: METAL

COR PRETO FOSCO

DIÂMETRO
60 CM/AJUSTÁVEL

LÂMPADA
5 X E27 - NÃO INCLUSA

LF 82018 A
Cód. 480

MATERIAL: **METAL**

COR: PRETO E BRONZE

DIÂMETRO	ALTURA	LÂMPADA
14 CM	32 CM	1 E27 NÃO INCLUSA



LF 82018 B
Cód. 481

MATERIAL: **METAL**

COR: BRANCO E BRONZE

DIÂMETRO	ALTURA	LÂMPADA
14 CM	32 CM	1 E27 NÃO INCLUSA



LF 82018 C
Cód. 482

MATERIAL: **METAL**

COR: BRANCO E BRONZE

DIÂMETRO	ALTURA	LÂMPADA
34 CM	20 CM	1 E27 NÃO INCLUSA



LF 2936
Cód. 2019

MATERIAL: METAL

COR PRETO E BRANCO

DIÂMETRO
25 CM

ALTURA
25CM

LÂMPADA
1 E27
NÃO INCLUSA

ALTURA COM
O CABO
100CM

LF 81677
Cód. 825

MATERIAL: METAL



OLD GOLD



PRETO

DIÂMETRO
25 CM

ALTURA
22CM

LÂMPADA
1 E27
NÃO INCLUSA

ALTURA COM
O CABO
100CM



LF 92143
Cód. 811

MATERIAL: METAL - MADEIRA

COR MADEIRA

DIÂMETRO
50 C M

ALTURA
50CM

LÂMPADA
06 E14
NÃO INCLUSA





LF 12140 14
Cód. 199



MATERIAL: METAL - ACRÍLICO

COR ÂMBAR

DIÂMETRO
30 CM

ALTURA
120CM

LÂMPADA

4 E14
NÃO INCLUSO



LF 81052 L1
Cód. 654

MATERIAL: METAL

COR: PRETO

DIÂMETRO
12 CM

ALTURA
50 CM

LÂMPADA ALTURA COM
1 E27 O CABO
NÃO INCLUSO 100CM



LF 2589 L8+4 COGNAC
Cód. 566

MATERIAL: METAL CROMADO - CRISTAL - VIDRO

COR: COGNAC

DIÂMETRO	LÂMPADA	ALTURA
80 CM	12 E14 NÃO INCLUSO	74CM



LF 2589 L5 COGNAC
Cód. 299

MATERIAL: METAL CROMADO -
CRISTAL - VIDRO

COR: COGNAC

DIÂMETRO	LÂMPADA	ALTURA
56 CM	5 E14 NÃO INCLUSO	56 CM

LF 2589 L8+4 TRANSPARENTE
Cód. 769

MATERIAL: METAL CROMADO - CRISTAL - VIDRO

COR TRANSPARENTE

DIÂMETRO	LÂMPADA	ALTURA
80 CM	12 E14 NÃO INCLUSO	74CM



LF 2589 L8 COGNAC
Cód. 550

MATERIAL: METAL CROMADO-CRISTAL-VIDRO

COR COGNAC

DIÂMETRO	LÂMPADA	ALTURA
64 CM	8 E14 NÃO INCLUSO	58CM



LF 2589 L3 TRANSPARENTE
Cód. 671

MATERIAL: METAL CROMADO - CRISTAL - VIDRO

COR TRANSPARENTE

DIÂMETRO	LÂMPADA	ALTURA
56 CM	3 E14 NÃO INCLUSO	56CM



LF 2589 L3 COGNAC
Cód. 499

MATERIAL: METAL CROMADO-CRISTAL-VIDRO

COR COGNAC

DIÂMETRO	LÂMPADA	ALTURA
56 CM	3 E14 NÃO INCLUSO	56CM

LF S01 L6 COGNAC
Cód. 26

MATERIAL: METAL - CRISTAL - VIDRO

COR: COGNAC

DIÂMETRO	LÂMPADA	ALTURA
58 CM	6 E14 NÃO INCLUSO	55CM



LF S01 A L6 TRANSPARENTE
Cód. 6

MATERIAL: METAL - CRISTAL - VIDRO

COR TRANSPARENTE

DIÂMETRO	LÂMPADA	ALTURA
58 CM	6 E14 NÃO INCLUSO	55CM



LF 8646 L6 WHITE
Cód. 470

MATERIAL: METAL - CRISTAL - VIDRO

COR: BRANCO

DIÂMETRO	LÂMPADA	ALTURA
55 CM	6 E14 NÃO INCLUSO	60CM



LF 8816 L6 BLACK
Cód. 653

MATERIAL: METAL - CRISTAL - VIDRO

COR PRETO

DIÂMETRO	ALTURA	LÂMPADA
56 CM	60CM	06 E14 NÃO INCLUSO





LF 6608C L6 COGNAC
Cód. 1

MATERIAL: METAL-CRISTAL-VIDRO

COR COGNAC

DIÂMETRO	LÂMPADA	ALTURA
60 CM	6 E14 NÃO INCLUSO	60CM

LF 3148 L8 COGNAC
Cód. 9

MATERIAL: METAL - CRISTAL - VIDRO

COR: COGNAC

DIÂMETRO	LÂMPADA	ALTURA
80 CM	8 E14 NÃO INCLUSO	65CM



LF S57 L6+1 TRANSPARENTE
Cód. 20

MATERIAL: METAL - CRISTAL - VIDRO

COR TRANSPARENTE

DIÂMETRO	ALTURA	LÂMPADA
60 CM	49CM	07 E14 NÃO INCLUSO



LF S57 L6+1 COGNAC

Cód. 21

MATERIAL: METAL - CRISTAL - VIDRO

COR COGNAC

DIÂMETRO 60 CM ALTURA 49CM LÂMPADA 07 E14
NÃO INCLUSO



LF 2653 L6

Cód. 650

MATERIAL: METAL - CRISTAL - VIDRO

COR AREIA COM DETALHES
CROMADOS

DIÂMETRO 68 CM LÂMPADA 6 E14 ALTURA 62CM
NÃO INCLUSO



LF S01 L8+4 TRANSPARENTE

Cód. 28

MATERIAL: METAL - CRISTAL - VIDRO

COR: TRANSPARENTE

DIÂMETRO 80 CM LÂMPADA 1 E14 ALTURA 75CM
NÃO INCLUSO

ARANDELAS



LF 3082
Cód. 834



MATERIAL: METAL

COR BRANCO FOSCO

DIMENSÕES **LED INCLUSO**
16X8CM 5W-3000K



LF 84614 L1 UNIQUE
Cód. 423



MATERIAL: METAL

COR BRANCO

LARGURA **ALTURA** **LED INCLUSO**
22 CM 19CM 5W-3000K

LF 81922
Cód. 461

MATERIAL: METAL

COR BRANCO

DIÂMETRO	ALTURA	LED INTEGRADO
9 CM	20 CM	BIVOLT
		15W-3000K

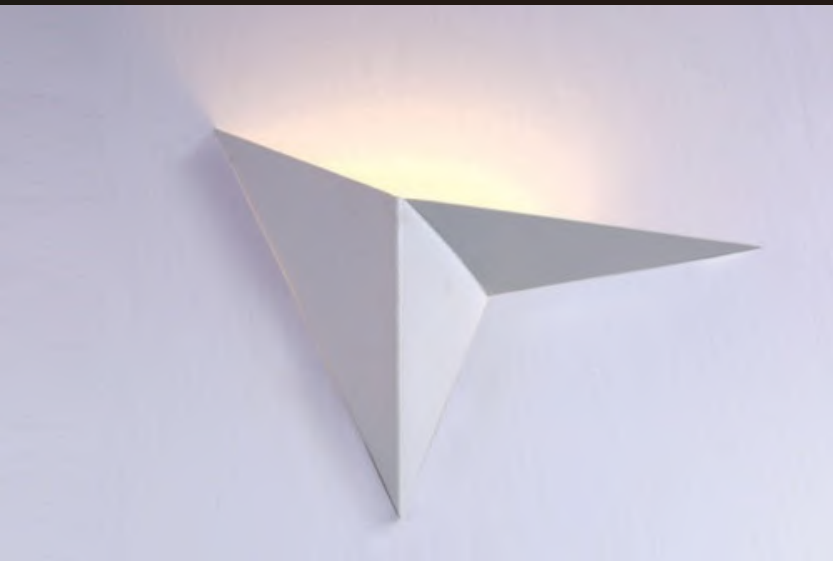

LF 81617
Cód. 426

MATERIAL: METAL

COR BRANCO

LARGURA	ALTURA	LED INCLUSO
37 CM	35CM	5W-3000K



LF B02-1
Cód. 833

MATERIAL: METAL

COR BRANCO FOSCO

DIMENSÕES	LED INCLUSO
10X10X8CM	5W-3000K





Biolucci

ILUMINAÇÃO

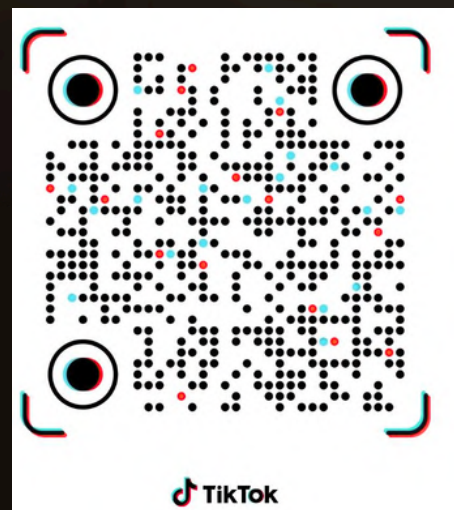
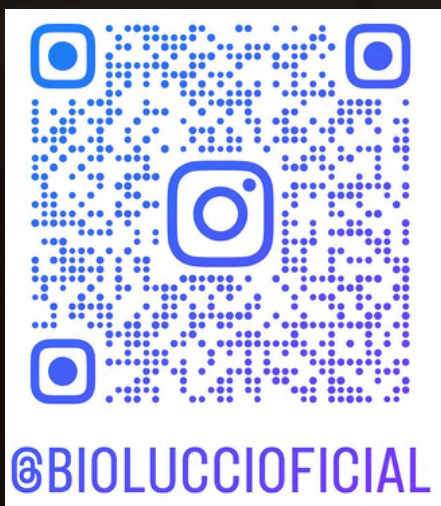

ACESSE:
BIOLUCCI.COM.BR